



product catalogue
2023



Profiles with profile

A powerful and efficient team is the base for our company success. We have faced the requirements of the market and are today the trademark for innovation, competence and quality in plastic manufacturing.

We relentless pursuit our focus on quality, also in products, processes and management. APU´s claim is to provide always the highest quality.

We confess a special responsibility to the environment, align each operational work to this subject and know the basics of saving resources as well as a lasting management.



INFO

ADVICE

Profiles are illustrated between 60% and 80%.

The basic size of the profiles are mm. Manufacturing differences and tolerances are subject to change.

Our standard program is only available in original packaging. We only deliver special colors and profiles by agreement. Over at all we reserve us other changes.

With this catalogue the older ones get null. Delivery will be carried out according to our delivery and payment conditions.

As may be the case of missprint there is no way of complaint. The colors in this sheet could be differ because of print technic.

MANUFACTURING ADVICE

These pictograms show the manufacturing advice we give to you.

two-component-mastic



BOLTA-scissors



BOLTA-hot glue gun



BOLTA-punch



ORANGE SET
WHITE SET
BLUE SET

CERTS

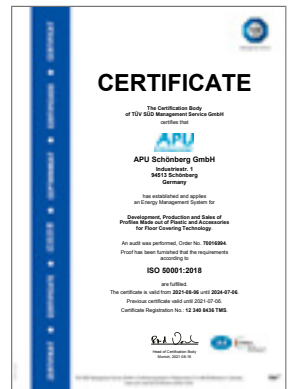

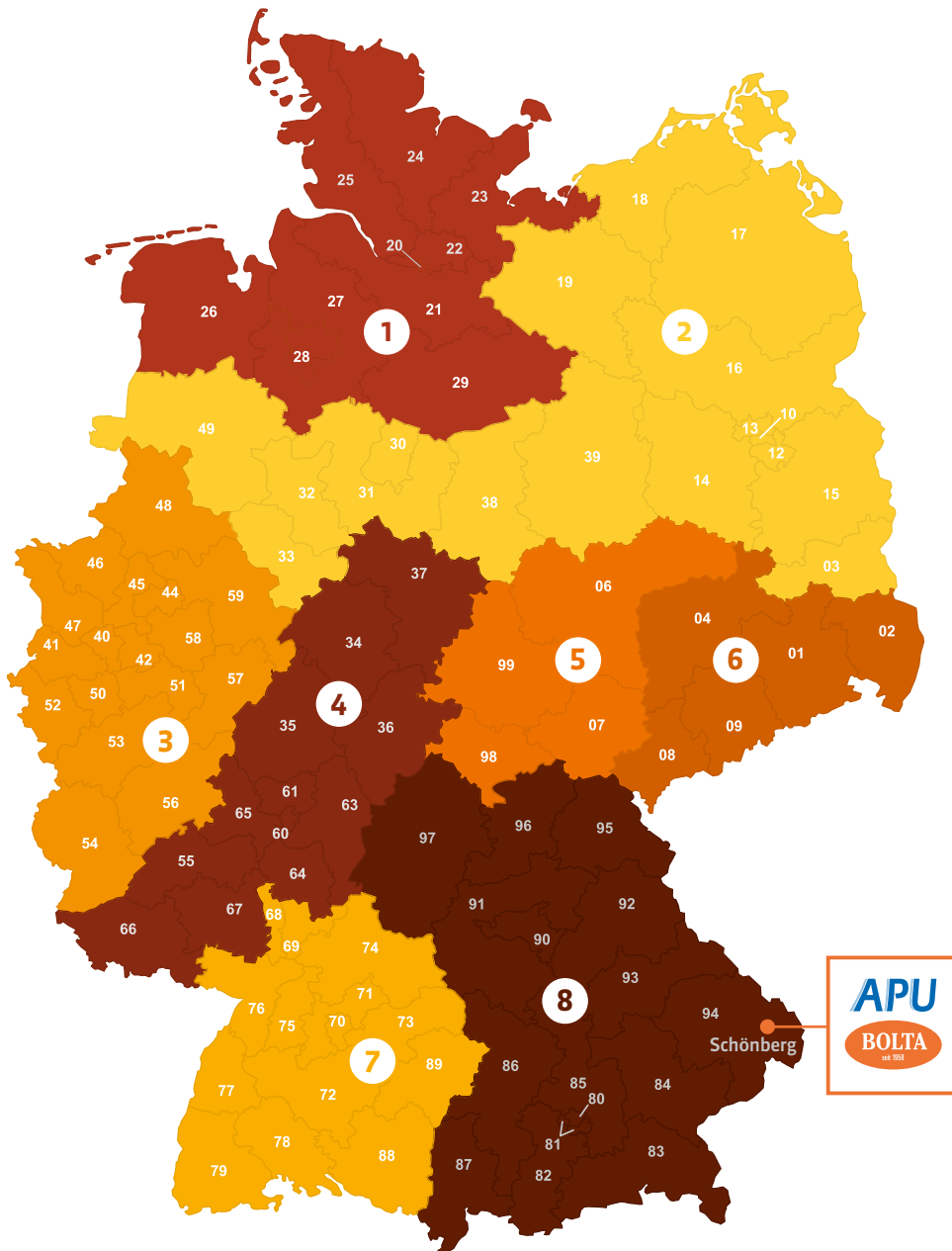

BOLTA-PROFILE-PARTNERS

- | | | |
|---|---|---|
| <p>1 Andrea Facklam
Handelsvertretung BOLTA Fußballprofile
Eckhoffkoppel 8b
22927 Großhansdorf
T 04102 - 65111
F 04102 - 691489
M 0160 - 7013414
@ a.facklam@t-online.de</p> | <p>2 Marco Kalbhen
Handelsvertretung BOLTA Fußballprofile
An den Leddigen 70
14476 Potsdam
T 033208 - 208965
F 033208 - 208966
M 0175 - 2047971
@ info@kalma-handel.de</p> | <p>3 André Schlepphorst
94513 Schönberg
M 0151 - 29501782
@ schlepphorst@abs-leisten.de</p> |
| <p>4 Frank Schmidt
Handelsvertretung BOLTA Fußballprofile
Bornackerweg 9
35232 Dautphetal
T 06468 - 7177
F 06468 - 1511
M 0172 - 8488536
@ schmidt-f@t-online.de</p> | <p>5 Marcel Bäßler
Handelsvertretung BOLTA Fußballprofile
Straße des Friedens 11b
04654 Frohburg OT Flößberg
M 0163 - 4774765
@ info@handelsagentur-baessler.de</p> | <p>6 Matthias Bäßler
Handelsvertretung BOLTA Fußballprofile
Finkenweg 18
04643 Geithain
T 034341 - 43277
F 034341 - 40804
M 0171 - 8239292
@ info@baessler-werkzeug.de</p> |
| <p>7 Stefan Elser
73527 Schwäbisch Gmünd
M 0151 - 11507509
@ elser.stefan@apu-schoenberg.de</p> | <p>8 Thomas Freund
Handelsvertretung BOLTA Fußballprofile
Schleifweg 20
97464 Niederwerrn
T 09726 - 1245
F 09726 - 1210
M 0160 - 98042329
@ t.freund@t-online.de</p> | <p>Zentrallager Bolta Fußballprofile
APU Schönberg GmbH
94513 Schönberg
T 08554 - 309-0
F 08554 - 309-50
@ info@apu-schoenberg.de</p> |



PRODUKTE

HARD-FOAM-SKIRTINGS

P. 6 - 19

CARPET-SKIRTINGS

P. 20 - 25

CLAMPING-SKIRTINGS

P. 26 - 27

CONCAVE-SKIRTINGS

P. 28 - 31

PLASTICISED-PVC-SKIRTINGS

P. 32 - 37

STAIR-NOSINGS

P. 38 - 43

SPECIAL-PROFILES

P. 44 - 55

TOOL/EQUIPMENT

P. 56 - 59

Classic floor skirtings

Within product innovation BOLTA has developed a large quote of hard-foam-skirtings, which are especially suited for objects. Particular the classic floor skirting, made out of foamed unplasticised-PVC in various sizes and styles with a rigid surface and nevertheless slight in weight. To work the skirting is very easy if you use the BOLTA-punch. This product family is immune to dampness and always keeps form. Two flexible lips to floor and wall drain off subsonic noise. We offer our established profile in selected 3-D or metal-decor-colors with structure or in wood optic.

HARD-FOAM-SKIRTING



Q 12-60M p. 8



Q 12-60H p. 8



Q 12-60G/B/N p. 9



Q 12-40G/B p. 10

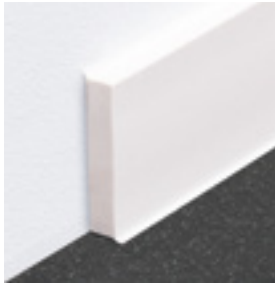

Q 16-80G/B p. 11



SL 60 p. 12



SL 80 p. 14



SL 100 p. 14



PSL 58/58F p. 15



MULTI-SL 60 p. 16

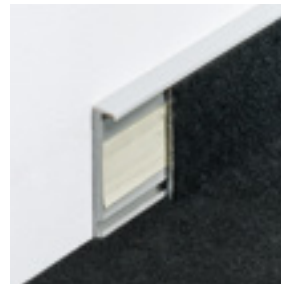

TSL 60 p. 17



SL 48M p. 18



BSL 60 p. 19

HARD-FOAM-SKIRTING

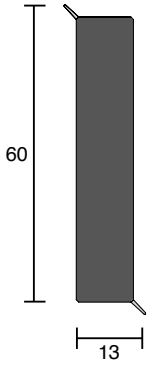

Q 12-60M

- + unplasticised PVC-foam-skirting in 60 mm headway
- + not affected by humidity or moisture, form-keeping
- + **metallic surface**

ARTICLE 10646

packaging unit/length
20 pcs per 2.5 m = 50 m

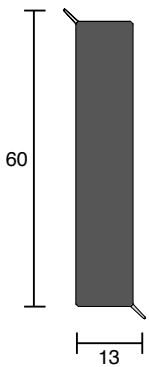
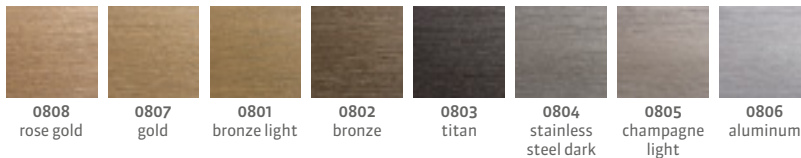

Q 12-60H

- + unplasticised PVC-foam-skirting in 60 mm headway
- + not affected by humidity or moisture, form-keeping
- + **wood colored surface**

ARTICLE 10670

packaging unit/length
20 pcs per 2.5 m = 50 m

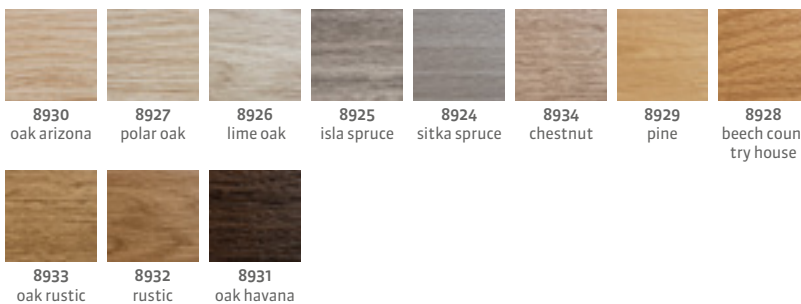

HARD-FOAM-SKIRTING

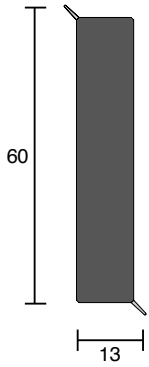

Q 12-60G

- + unplasticised PVC-foam-skirting in 60 mm headway
- + not affected by humidity or moisture, form-keeping
- + **smooth surface**



ARTICLE 10655

packaging unit/length
20 pcs per 2.5 m = 50 m

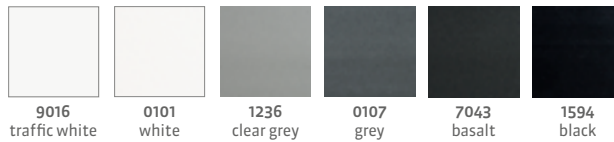

Q 12-60B

- + unplasticised PVC-foam-skirting in 60 mm headway
- + not affected by humidity or moisture, form-keeping
- + **brushed surface**

ARTICLE 10645

packaging unit/length
20 pcs per 2.5 m = 50 m



Q 12-60N

- + unplasticised PVC-foam-skirting in 60 mm headway
- + not affected by humidity or moisture, form-keeping
- + **grainy structured surface**

ARTICLE 10650

packaging unit/length
20 pcs per 2.5 m = 50 m



HARD-FOAM-SKIRTING

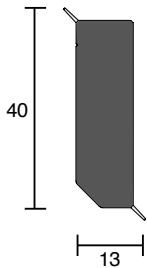

Q 12-40G

- + unplasticised PVC-foam-skirting in 40 mm headway
- + not affected by humidity or moisture, form-keeping
- + **smooth surface**



ARTICLE 10640

packaging unit/length
30 pcs per 2.5 m = 75 m



9016
traffic white

Q 12-40B

- + unplasticised PVC-foam-skirting in 40 mm headway
- + not affected by humidity or moisture, form-keeping
- + **brushed surface**

ARTICLE 10641

packaging unit/length
30 pcs per 2.5 m = 75 m



9016
traffic white

HARD-FOAM-SKIRTING

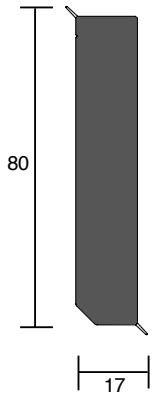

Q 16-80G

- + unplasticised PVC-foam-skirting in 80 mm headway
- + not affected by humidity or moisture, form-keeping
- + **smooth surface**



ARTICLE 10680

packaging unit/length
10 pcs per 2.5 m = 25 m



9016
traffic white

Q 16-80B

- + unplasticised PVC-foam-skirting in 80 mm headway
- + not affected by humidity or moisture, form-keeping
- + **brushed surface**

ARTICLE 10681

packaging unit/length
10 pcs per 2.5 m = 25 m



9016
traffic white

HARD-FOAM-SKIRTING

with
new
Technology

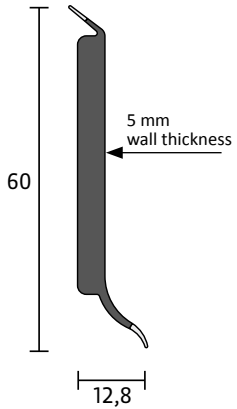

SL 60

- + unplasticised PVC-foam-skirting in 60 mm headway
- + not affected by humidity or moisture, form-keeping
- + imbued, flexible lips to floor and wall

ARTICLE 10560

packaging unit/length
25 pcs per 4 m = 100 m



ARTICLE 25560

packaging unit/length
40 pcs per 2.5 m = 100 m



EQUIPMENT

internal corner

article 22842
50 pieces/color

external corner

article 22843
50 pieces/color

finish cap left

article 22845
50 pieces/color

finish cap right

article 22844
50 pieces/color

colors

0101 white	0107 grey	0272 clear beige
1236 clear grey	1594 black	8740 silver

+ flexible
 + insensitive to temperature
 + no embrittlement

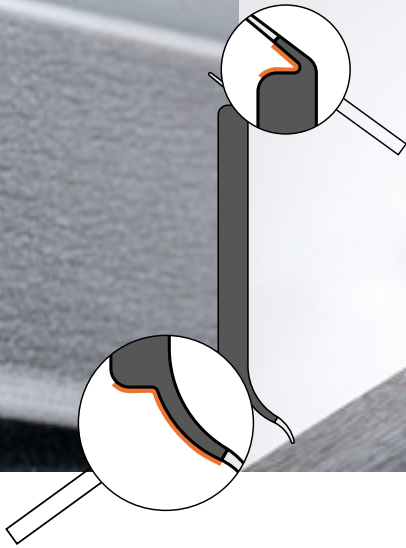

ARTICLE 10560

packaging unit/length
 25 pcs per 4 m = 100 m



ARTICLE 25560

packaging unit/length
 40 pcs per 2.5 m = 100 m



* up to now SL 60 Design
 with transparent flexible lip

EQUIPMENT

internal corner	external corner	finish cap left	finish cap right	colors		
article 22842 50 pieces/color	article 22843 50 pieces/color	article 22845 50 pieces/color	article 22844 50 pieces/color	8538 oak	8619 beech select	8661 beech
				8662 maple	8695 wenge	8702 walnut dark

HARD-FOAM-SKIRTING

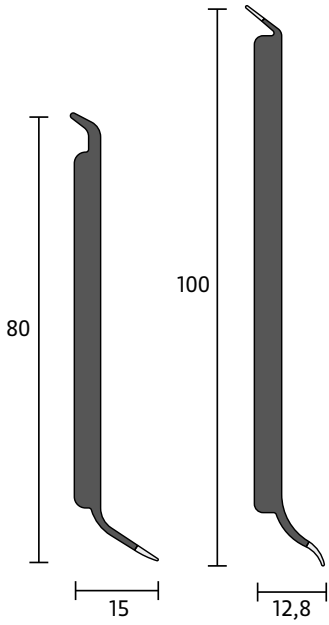

SL 80

- + unplasticised PVC-foam-skirting in 80 mm headway
- + not affected by humidity or moisture, form-keeping
- + imbued, flexible lip to the floor



ARTICLE 10575

packaging unit/length
25 pcs per 4 m = 100 m

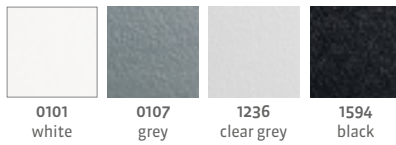

SL 100

- + unplasticised PVC-foam-skirting in 100 mm headway
- + not affected by humidity or moisture, form-keeping
- + imbued, flexible lips to floor and wall

ARTICLE 10590

packaging unit/length
25 pcs per 4 m = 100 m

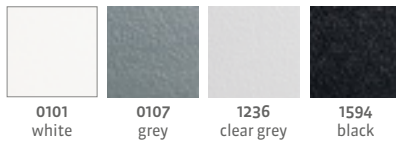

HARD-FOAM-SKIRTING

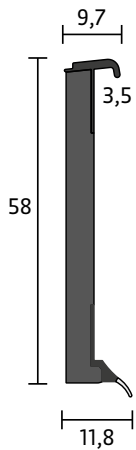

PSL 58

- + unplasticised PVC-foam-skirting in 58 mm headway
- + not affected by humidity or moisture, form-keeping
- + ready to paste in floors
- + shadow gap to the wall, **transparent** lip to the floor



ARTICLE 10669

packaging unit/length
25 pcs per 4 m = 100 m

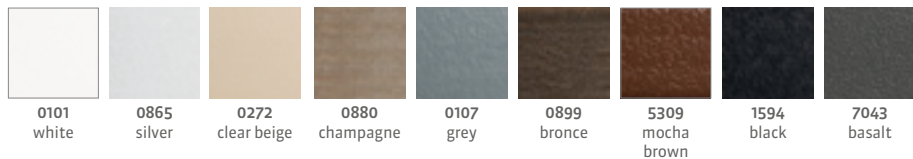

ARTICLE 25669

packaging unit/length
20 pcs per 2.5 m = 50 m

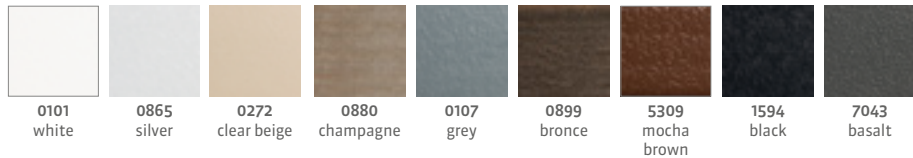

PSL 58F

- + unplasticised PVC-foam-skirting in 58 mm headway
- + not affected by humidity or moisture, form-keeping
- + ready to paste in floors
- + shadow gap to the wall, **imbued** lip to the floor

ARTICLE 10669

packaging unit/length
25 pcs per 4 m = 100 m

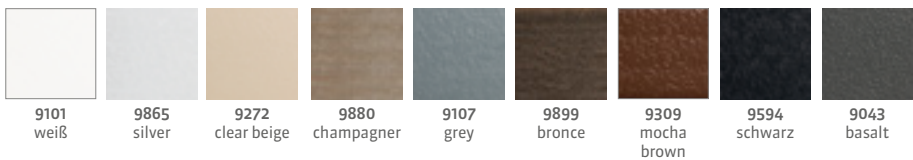

ARTICLE 25669

packaging unit/length
20 pcs per 2.5 m = 50 m

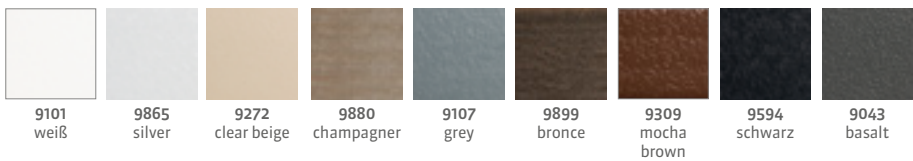

EQUIPMENT

finish cap right

article 22838
50 pieces/color

finish cap left

article 22839
50 pieces/color

colors

0101 white	0107 grey	0272 clear beige	0865 silver
0880 champagne	0899 bronze	1594 black	5309 mocha brown

HARD-FOAM-SKIRTING

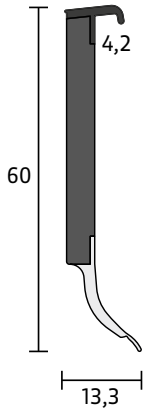

MULTI-SL 60

- + unplasticised PVC-foam-skirting in 60 mm headway
- + ready to paste in floors
- + not affected by humidity or moisture, form-keeping
- + transparent flexible lip to the floor



ARTICLE 10660

packaging unit/length
30 pcs per 4 m = 120 m



HARD-FOAM-SKIRTING

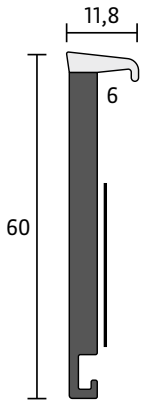

TSL 60

- + unplasticised PVC-foam-skirting in 60 mm headway
- + ready to paste in floors
- + not affected by humidity or moisture, form-keeping
- + flexible roof



ARTICLE 10665

packaging unit/length
25 pcs per 4 m = 100 m



HARD-FOAM-SKIRTING

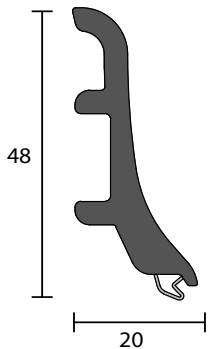

SL 48M

- + unplasticised PVC-foam-skirting in 48 mm headway
- + not affected by humidity or moisture, form-keeping
- + metal clip, art. 22030 not in delivery range
- + invisible soft lip

ARTICLE 10589

packaging unit/length
40 pcs per 2.5 m = 100 m

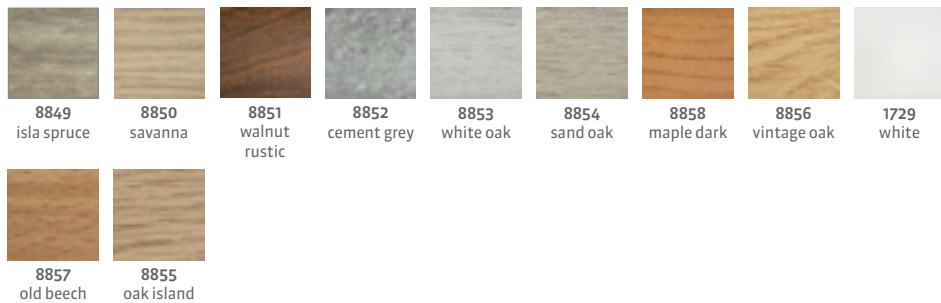

CLIP

ARTICLE 22030

packaging unit/length
1 unit per 50 pcs

- + metal clip for assembling
- + multiple mounting and demounting possible

EQUIPMENT

internal corner

article 22870
50 pieces/color

external corner

article 22871
50 pieces/color

finish cap left

article 22880
50 pieces/color

finish cap right

article 22881
50 pieces/color

connection

article 22882
50 pieces/color

colors

1729 white	8849 isla spruce	8850 savanna	8851 walnut rustic
8852 cement grey	8853 white oak	8854 sand oak	8855 oak island
8856 vintage oak	8857 old beech	8858 maple dark	8859 maple nature

HARD-FOAM-SKIRTING

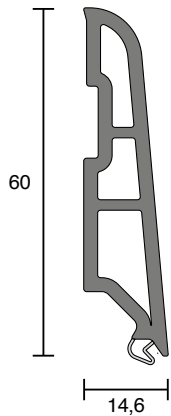

BSL 60

- + unplasticised PVC-foam-skirting in 60 mm headway
- + not affected by humidity or moisture, form-keeping
- + invisible soft lip



ARTICLE 10537

packaging unit/length
28 pcs per 2.5 m = 70 m

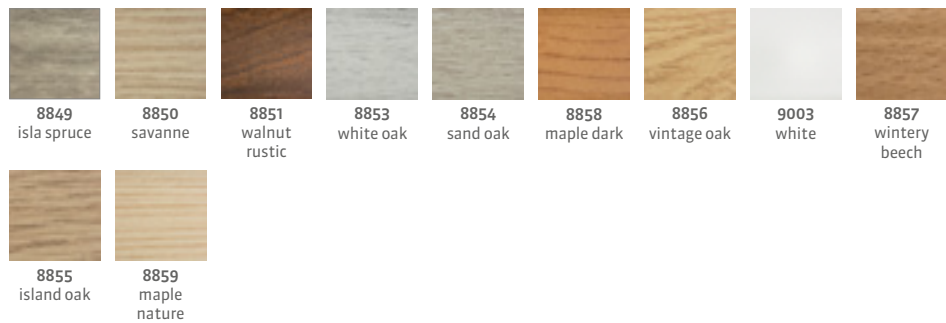

EQUIPMENT

internal corner	external corner	finish cap left	finish cap right
article 22810 50 pieces/color	article 22811 50 pieces/color	article 22815 50 pieces/color	article 22814 50 pieces/color

colors			
8849 isla spruce	8850 savanne	8851 walnut rustic	8853 white oak
8854 sand oak	8856 vintage oak	8858 maple dark	8855 island oak
8857 wint. beech	8859 maple nature	9003 white	



Profiles for textiles

The skirtings are produced in various styles and colors and guarantee a stunning combination to textile flooring. Our range involves solutions out of foamed-plasticised-PVC, combined materials like rigid-PVC with a soft roof, and new skirtings made out of polypropylen(PP). The chlorine free profile can be easily cut with simple profile scissors. Each profile version has it's own characteristics like the self adhesive types, which are specially made for your object. Beyond a high range of equipment alleviates your work.

CARPET-SKIRTING



TSL 55/6 p. 22



TSL 55/6-SK p. 22

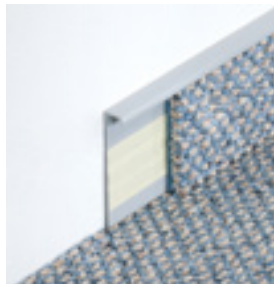

TSL 55/7 p. 23



TSL 55/7-SK p.24

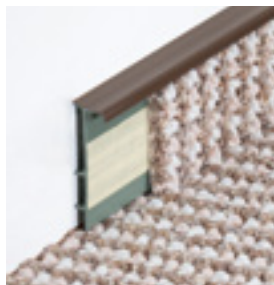

TSL 55/9 p. 25

CARPET-SKIRTING

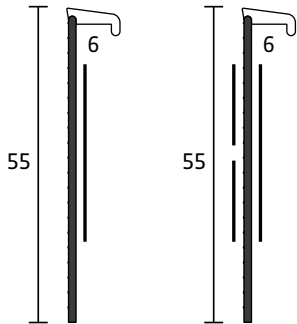

TSL 55/6

- + unplasticised PVC-skirting in 55 mm headway with a soft roof
- + self adhesive area integrated
- + specially appropriated for complete textile carpets

ARTICLE 10387

packaging unit/length
25 pcs per 4 m = 100 m



ARTICLE 25387

packaging unit/length
40 pcs per 2.5 m = 100 m



TSL 55/6-SK

- + unplasticised PVC-skirting in 55 mm headway with a soft roof
- + self adhesive area with very high stick-attribute
- + specially appropriated for complete textile carpets
- + rearside with foam tape

ARTICLE 17387

packaging unit/length
40 pcs per 2.5 m = 100 m



CARPET-SKIRTING

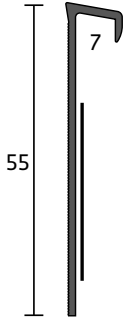

TSL 55/7

+ unplasticised-PVC-skirting in 55 mm headway
+ self adhesive area in front

ARTICLE 10443

packaging unit/length
30 pcs per 4 m = 120 m

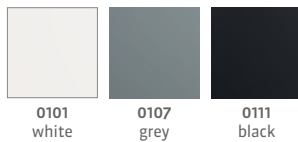

ARTICLE 25443

packaging unit/length
40 pcs per 2.5 m = 100 m

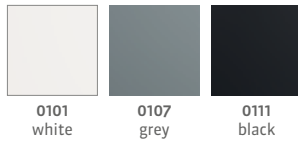

EQUIPMENT

internal corner

article 22885
100 pieces/color

external corner

article 22886
100 pieces/color

colors

0101 white	0107 grey	0111 black
---------------	--------------	---------------

CARPET-SKIRTING

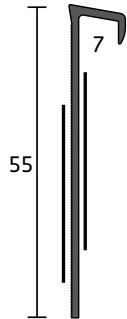

TSL 55/7-SK

- + unplasticised PVC-skirting in 55 mm headway
- + self adhesive area in front
- + rearside adhesive

ARTICLE 17443

packaging unit/length
40 pcs per 2.5 m = 100 m



0101
white

EQUIPMENT

internal corner

article 22885
100 pieces/color

external corner

article 22886
100 pieces/color

colors

0101 white	0107 grey	0111 black
---------------	--------------	---------------

CARPET-SKIRTING

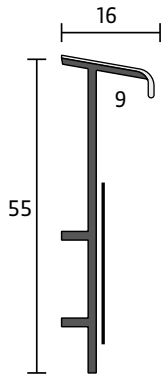

TSL 55/9

+ unplasticised PVC-skirting in 55 mm headway with a soft roof
+ self adhesive area in front

ARTICLE 10482

packaging unit/length
25 pcs per 4 m = 100 m



0101
white

ARTICLE 25482

packaging unit/length
40 pcs per 2.5 m = 100 m



0101
white

EQUIPMENT

internal corner	external corner	finish cap left	finish cap right	colors
article 22850 100 pieces/color	article 22851 100 pieces/color	article 22860 50 pieces/color	article 22861 50 pieces/color	0101 white

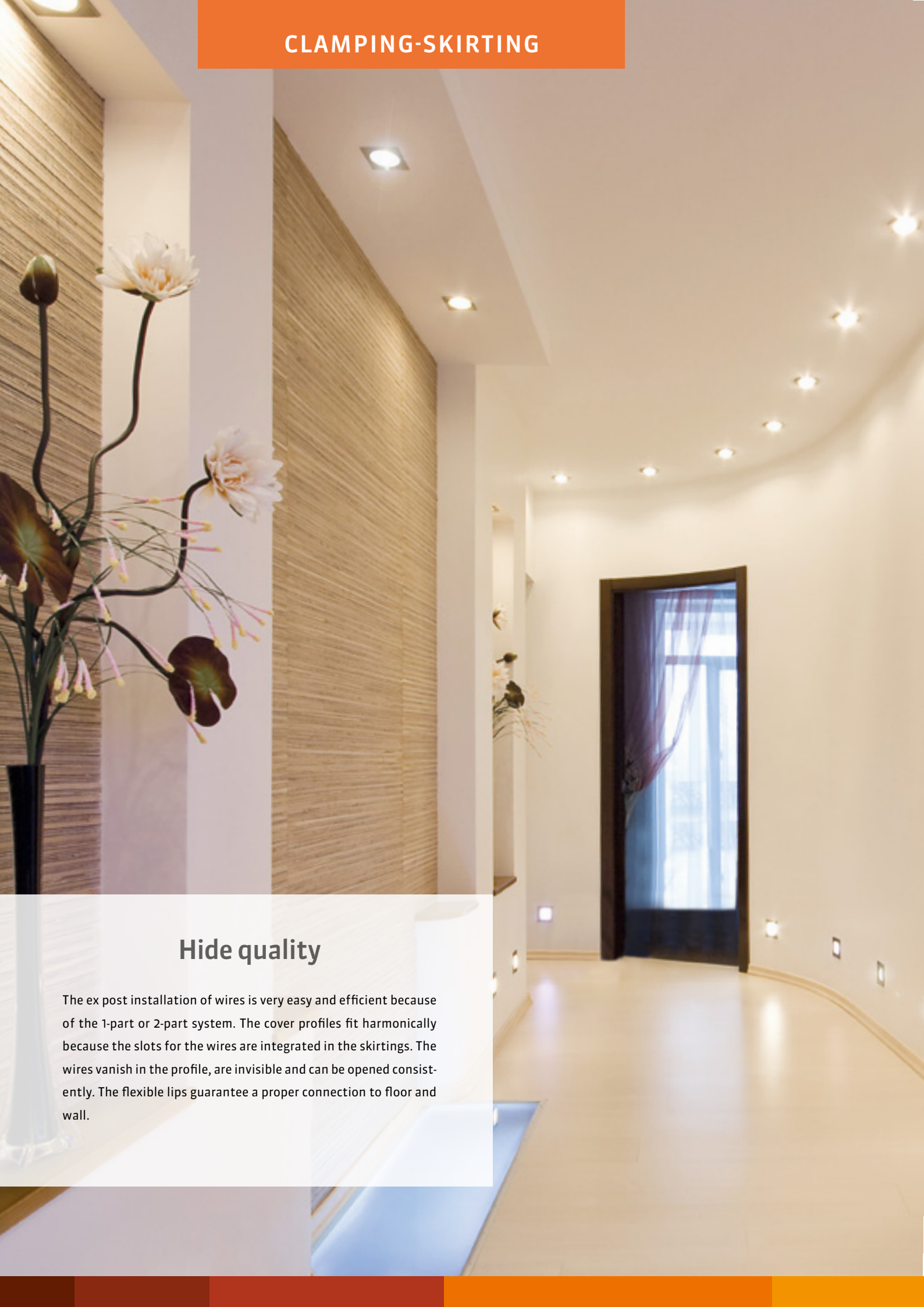

Hide quality

The ex post installation of wires is very easy and efficient because of the 1-part or 2-part system. The cover profiles fit harmonically because the slots for the wires are integrated in the skirtings. The wires vanish in the profile, are invisible and can be opened consistently. The flexible lips guarantee a proper connection to floor and wall.

CLAMPING-SKIRTING

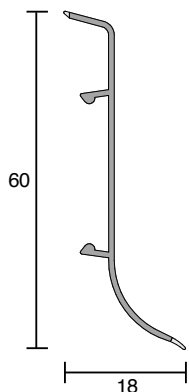

KSL 60

+ unplasticised PVC-skirting in 60 mm headway
+ plastic clip for assembling with art. 22025 + 22026
not included in delivery range

ARTICLE 10421

packaging unit/length
25 pcs per 4 m = 100 m



CLIP

ARTICLE 22025
ARTICLE 22026

due to page 56

EQUIPMENT

internal corner

article 22890
50 pieces/color

external corner

article 22891
50 pieces/color

finish cap left

article 22895
50 pieces/color

finish cap right

article 22896
50 pieces/color

colors

0101 white	0295 beige
---------------	---------------



Skirtings protect

This skirting has been developed in cooperation with experienced craftsmen for areas, which are most hygiene sensible. The floor can be raised without building corners, when mounting a concave skirting. Ugly and distracting corners could be avoided through radius formation. Benefit from our experience!

CONCAVE-SKIRTING



HKSL 2,5 p. 30



HKSL 3 p. 30



HKP 16-50 p. 31

CONCAVE-SKIRTING

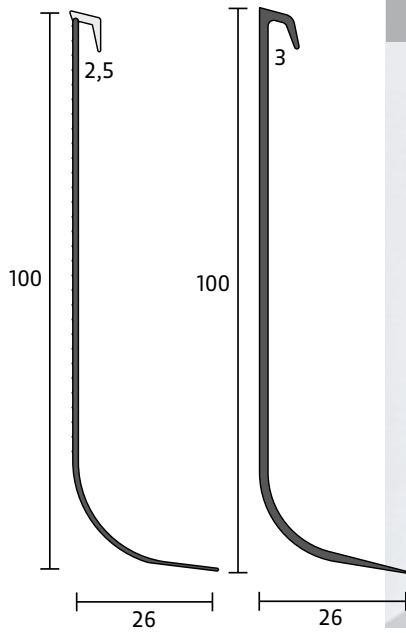

HKSL 2,5

- + unplasticised PVC-skirting in 100 mm headway
- + specially developed for your object
- + soft roof

ARTICLE 24885

packaging unit/length
40 pcs per 2.5 m = 100 m



HKSL 3

- + unplasticised PVC-skirting in 100 mm headway
- + specially developed for your object

ARTICLE 10883

packaging unit/length
25 pcs per 4 m = 100 m



CONCAVE-SKIRTING

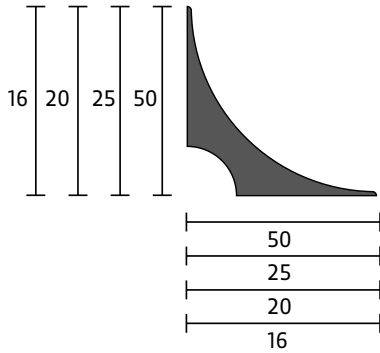

HKP 16-50

- + concave-skirting in various headways
- + for flooring implementation with raised PVC-floors and a neatless wall-floor-footbridge
- + specially for linolium floors
- + combination with various end profiles possible (picture)

ARTICLE 20000

HKP 16 x 16

packaging unit/length
20 pcs per 2.5 m = 50 m
2 rolls per 30 m = 60 m



0111
black

ARTICLE 20299

HKP 20 x 20

packaging unit/length
20 pcs per 2.5 m = 50 m



0111
black

ARTICLE 20399

HKP 25 x 25

packaging unit/length
20 pcs per 2.5 m = 50 m
3 rolls per 25 m = 75 m



0111
black

ARTICLE 20400

HKP 50 x 50

packaging unit/length
10 pcs per 2.5 m = 25 m



0111
black

Skirtings for your object

The profile guarantees an easy and functional wall protection and provide the necessary, individual closure to the wall. The flexible skirtings which can be delivered on rolls, are easy to transport and handle. Additionally we sublimate the skirtings with die stamping to guarantee a high-class surface and a great view. The formation of internal and external corners can be carried out endlessly from the roll. More information for competent hauling you find in our product sheets. Choose the right color out of a considerable line!.



PLASTICISED-PVC-SKIRTING



WSL 50/15 p. 34
OBJEKT-SK



WSL 50/15 p. 34

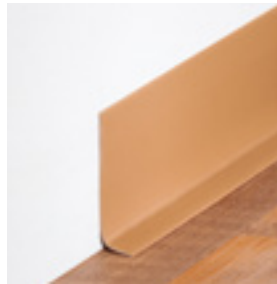

WSL 60/16 p. 35
OBJEKT-SK

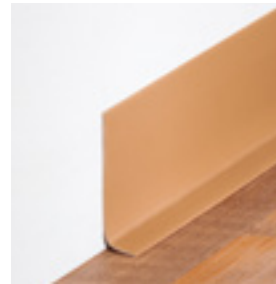

WSL 60/16 p. 35

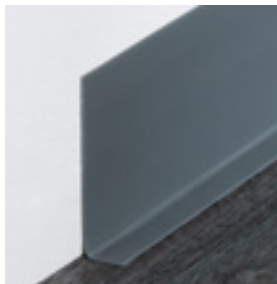

WSL 80/18 p. 36



WSL 100/20 p. 37

PLASTICISED-PVC-SKIRTING

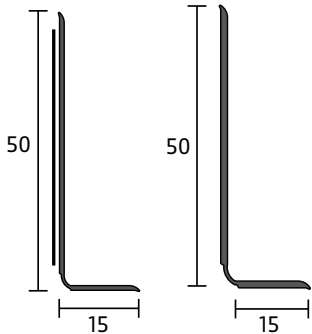

WSL 50/15 OBJEKT-SK

- + plasticised PVC-skirting in 50 mm headway to the wall
- + self adhesive rear with a high quality acrylic-tape
- + REACH compliant

ARTICLE 10224

packaging unit/length
1 roll per 50 m

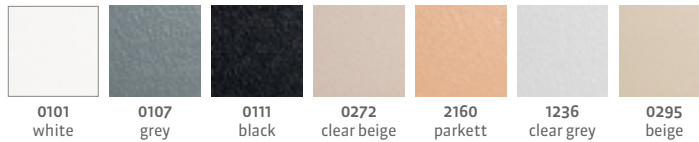

WSL 50/15

- + plasticised PVC-skirting in 50mm headway to the wall for your object
- + REACH compliant

ARTICLE 10310

packaging unit/length
2 rolls per 50 m = 100 m

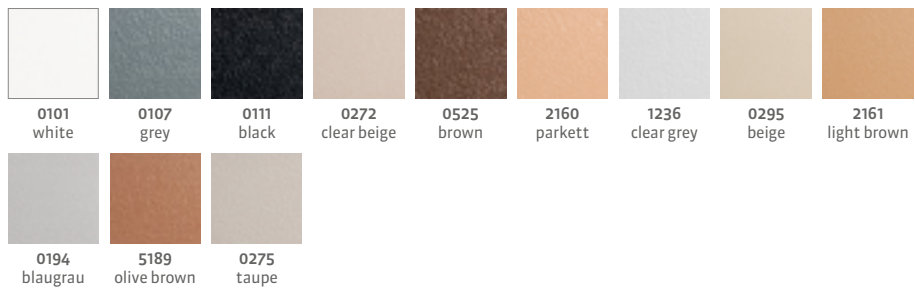

ARTICLE 10510

packaging unit/length
2 rolls per 50 m = 100 m

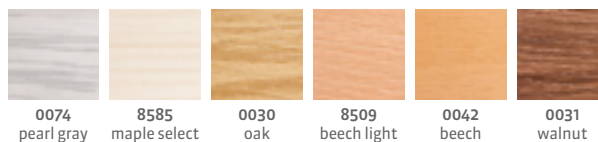

PLASTICISED-PVC-SKIRTING

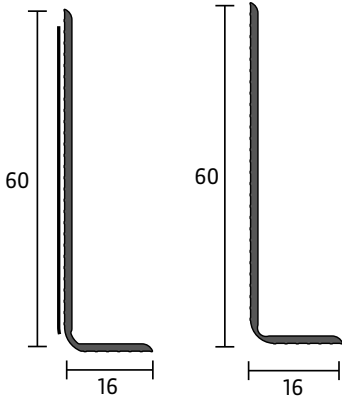

WSL 60/16 OBJEKT-SK

- + plasticised PVC-skirting in 60 mm wall headway
- + self adhesive rear with a high quality acrylic-tape
- + REACH compliant

ARTICLE 10233

packaging unit/length
1 roll per 50 m

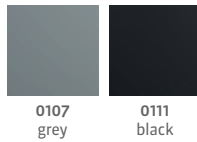

WSL 60/16

- + plasticised PVC-skirting in 60 mm wall headway for your object
- + REACH compliant

ARTICLE 10333

packaging unit/length
1 roll per 50 m



PLASTICISED-PVC-SKIRTING

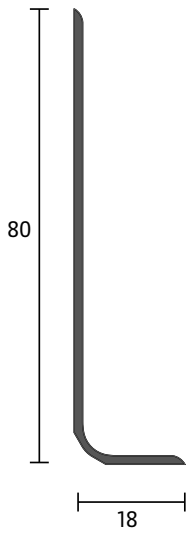

WSL
80/18

- + plasticised PVC-skirting in 80 mm headway to the wall for your object
- + REACH compliant

ARTICLE 10335

packaging unit/length

1 roll per 50 m

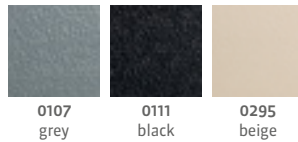

PLASTICISED-PVC-SKIRTING

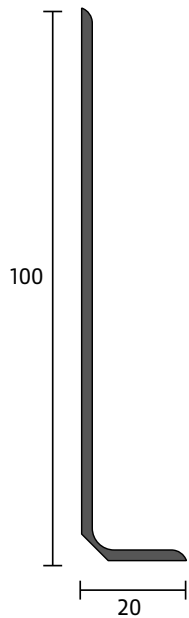

WSL
100/20

+ plasticised PVC-skirting in 100 mm headway to the wall for your object
+ REACH compliant

ARTICLE 10340

packaging unit/length

1 roll per 50 m



0107
grey

0111
black

0295
beige

Stair nosings need profile

These skirtings are specially intend to combine homogenous flooring or textile flooring to wood, stone or concrete. Take new skirtings for your object and enjoy the modern, valorise look. Profit by the non-skid effect of the plastic profile, which prevents from accidents in staircase areas.

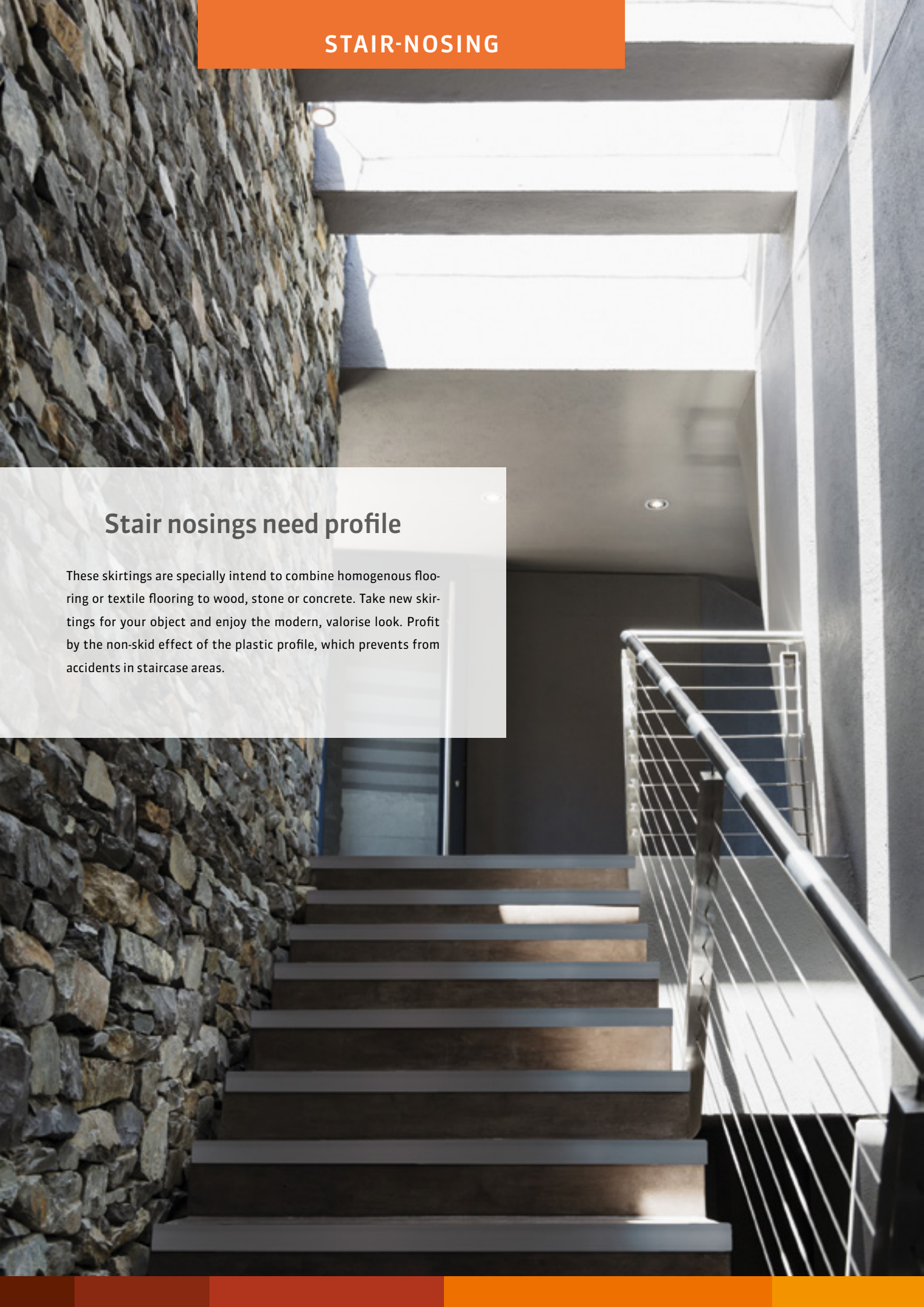

STAIR-NOSING

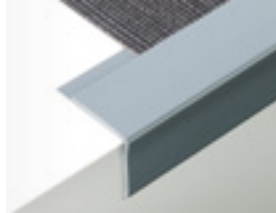

TK 45/42/2,5 p. 40



TK 45/42/3 p. 40



TK 60/42 p. 41



TK 40/25/2 p. 41

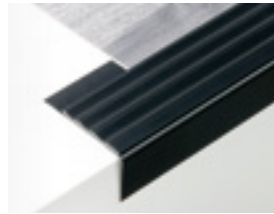

TK 45/30/3 p. 42

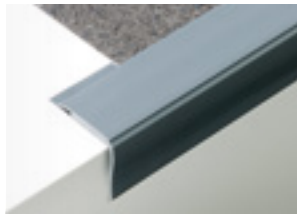

TEK 30/42/3 p. 42

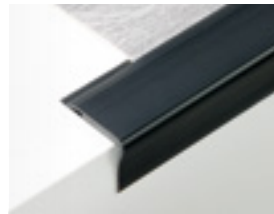

TEK 30/35/3 p. 43

STAIR-NOSING

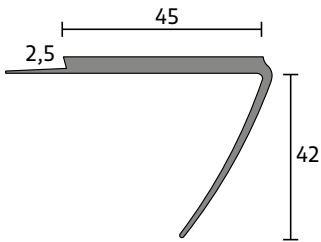
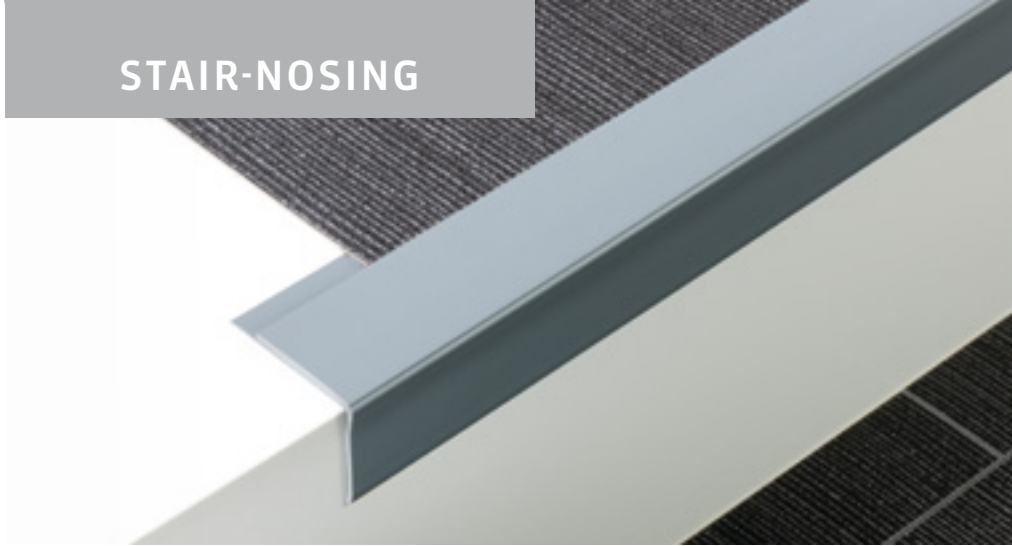

TK
45/42/2,5

ARTICLE 13389

packaging unit/length
20 pcs per 2.5 m = 50 m

+ stair-nosing of plasticised PVC in 45 x 42 mm headway
+ unruffled surface

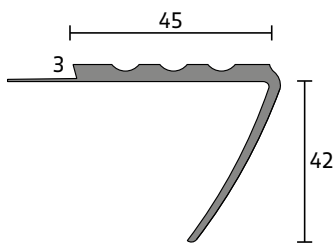
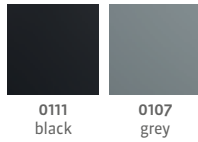

TK
45/42/3

ARTICLE 13364

packaging unit/length
20 pcs per 2.5 m = 50 m

+ stair-nosing of plasticised PVC in 45 x 42 mm headway
+ ruffled surface



STAIR-NOSING

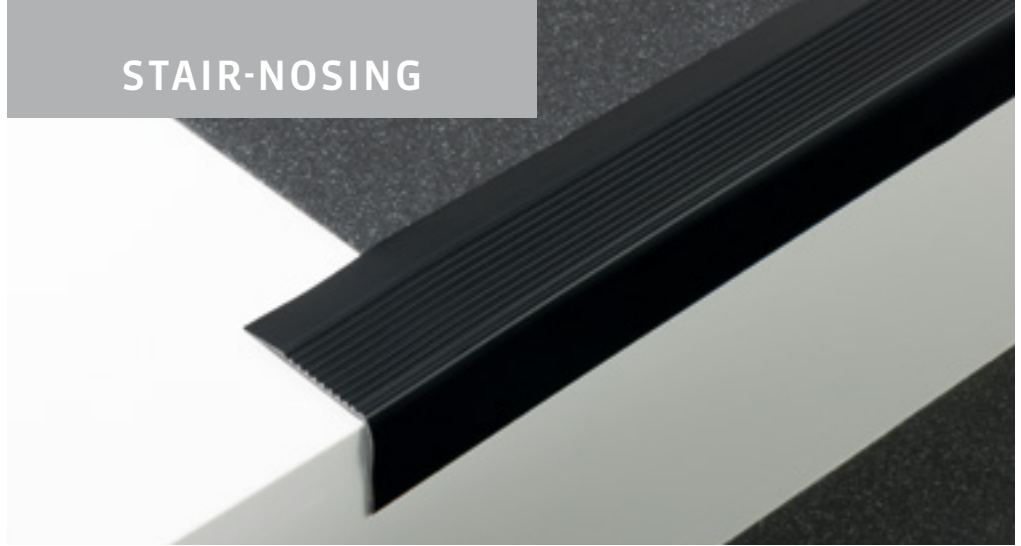
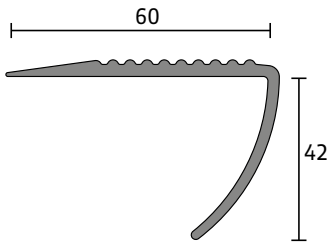

TK 60/42

ARTICLE 13420

packaging unit/length
20 pcs per 2.5 m = 50 m

+ stair-nosing of plasticised PVC in 60 x 42 mm headway
+ ruffled surface

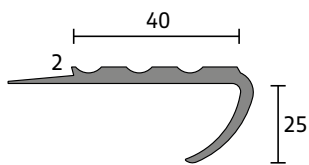
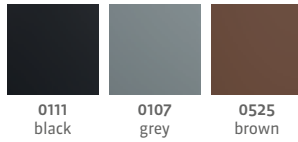

TK 40/25/2

ARTICLE 13385

packaging unit/length
20 pcs per 2.5 m = 50 m

+ stair-nosing of plasticised PVC in 40 x 25 mm headway
+ ruffled surface



STAIR-NOSING

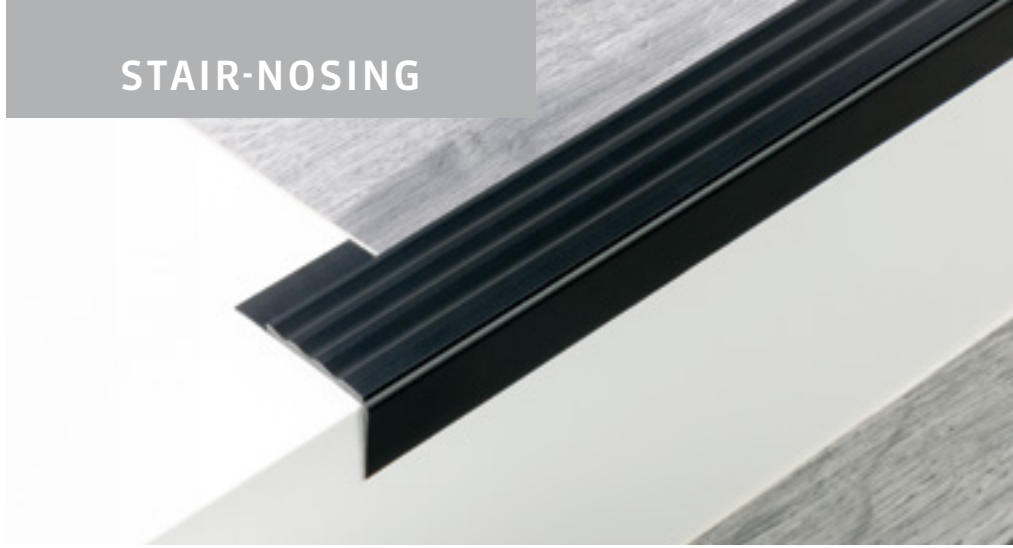
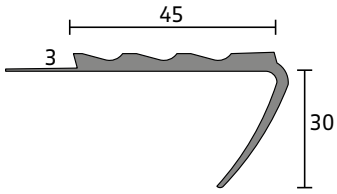

TK
45/30/3

ARTICLE 13353

packaging unit/length
20 pcs per 2.5 m = 50 m

+ stair-nosing of plasticised PVC in 45 x 30 mm headway
+ ruffled surface



0111
black

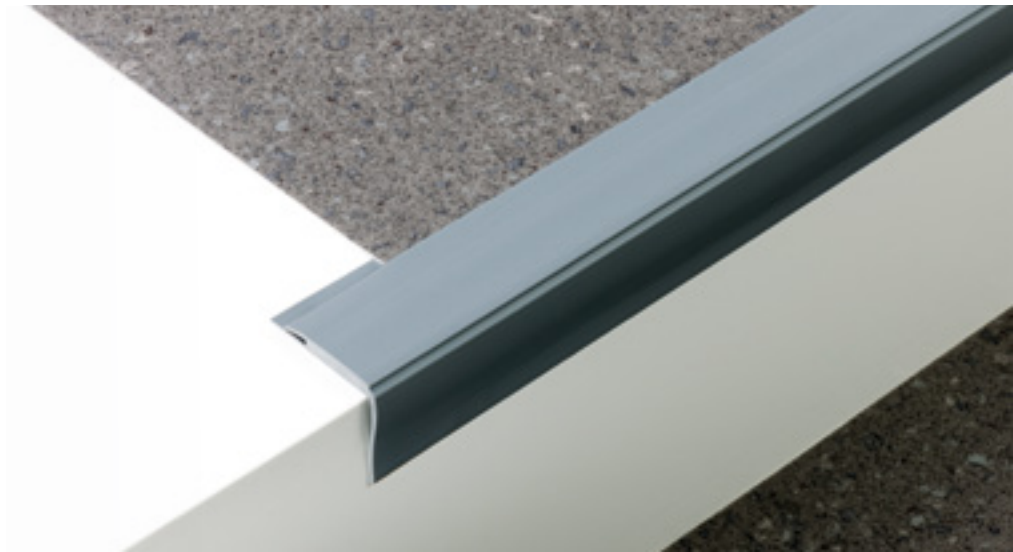
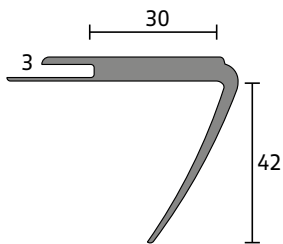

TEK
30/42/3

ARTICLE 19397

packaging unit/length
20 pcs per 2.5 m = 50 m

+ stair-nosing of plasticised PVC in 30 x 42 mm headway
+ unruffled surface



0111
black



0107
grey



0525
brown

STAIR-NOSING

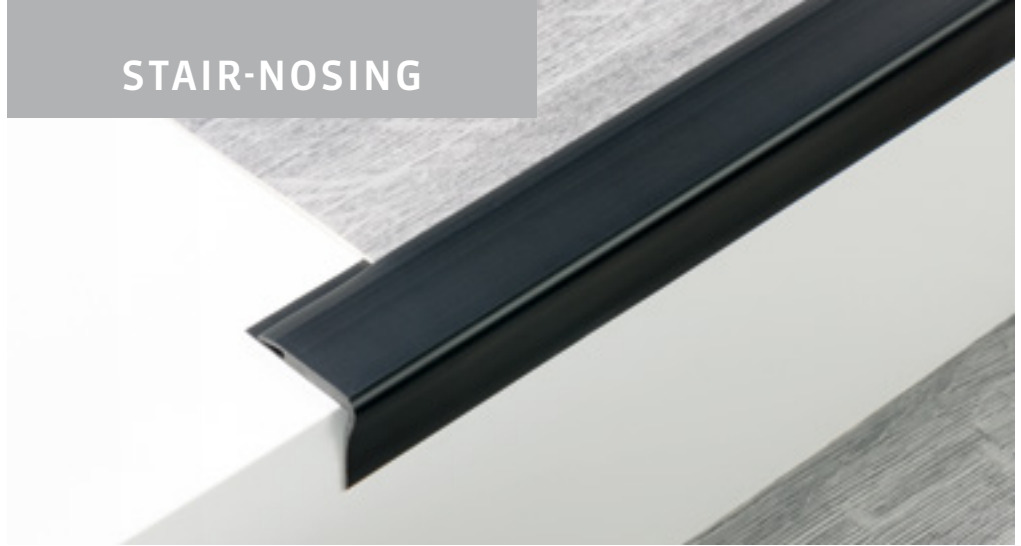
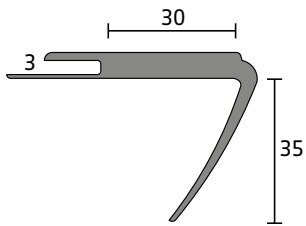

TEK
30/35/3

+ stair-nosing of plasticised PVC in 30 x 35 mm headway
+ unrippled surface

ARTICLE 19392

packaging unit/length
20 pcs per 2.5 m = 50 m



0111
black

0107
grey

Sophisticated requirements

This product range includes numerous profiles for floors, walls and ceilings, made out of foamed, plasticised and unplasticised PVC. For each problem we provide a special profile as solution, for example profiles for edge protection, covings, border-strips, finish-profiles and crossing-profiles. APU offers you the possibility to develop new profile solutions in cooperation, means customer related production of the tool and realisation of a new profile. In this case we indicate to the edge profile article number 32230, which has highly alleviated the work of painter and decorator.

SPECIAL-PROFILES



AL 32/3 p. 46



AL 32/6,5 p. 46



SSP 24,5 p. 47
AL 18



FP 52 p. 48



EFS p. 48
24/35/6 SK

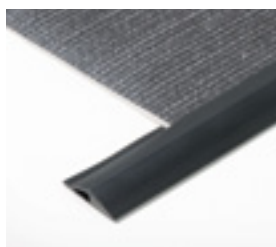

EFS p. 49
28/32/5 SK

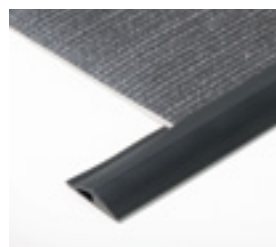

EFS p. 49
28/32/5



GS 23 SK p. 50



GS 27 p. 50

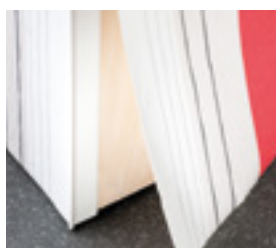

TEP 22 p. 51

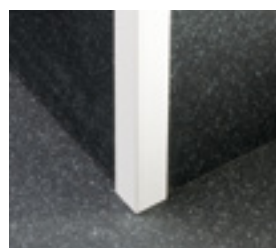

WL 20/20 p. 51



STW 54 / p. 52
STW 54 SK



KL 40 p. 53

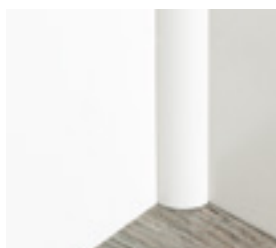

VST 14 p. 54



VST 20 p. 54



UEL 40 p. 55

SPECIAL-PROFILES

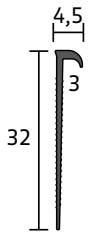

AL 32/3

- + unplasticised PVC-end-profile in 32 mm headway
- + multi-functional
- + to combine with art. page 28

ARTICLE 20334

packaging unit/length
25 pcs per 4 m = 100 m

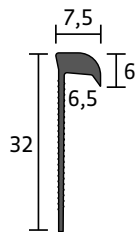
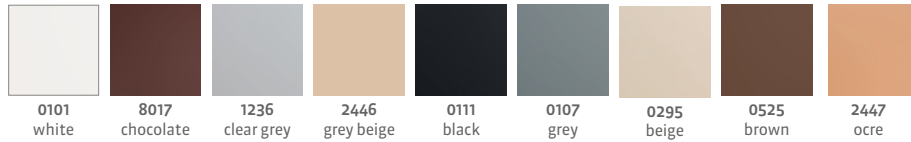

AL 32/6,5

- + unplasticised PVC-end-profile in 32 mm headway
- + to combine with flooring up to and including 6.5 mm of size

ARTICLE 20333

packaging unit/length
25 pcs per 4 m = 100 m

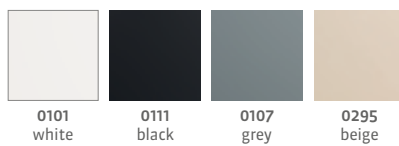

SPECIAL-PROFILES

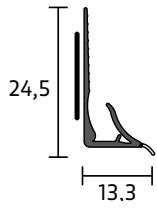

SSP 24,5

- + unplasticised end-profile in 24.5 mm headway
- + flexible, transparent lips to wall and floor
- + self adhesive tape at the rearside
- + suitable for vinyl and PVC flooring up to 3 mm

ARTICLE 25700

packaging unit/length
40 pcs per 2.5 m = 100 m

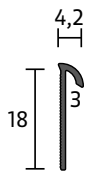

AL 18

- + unplasticised PVC-closing-profile in 18 mm headway
- + for multiple using

ARTICLE 20311

packaging unit/length
40 pcs per 2.5 m = 100 m



SPECIAL-PROFILES

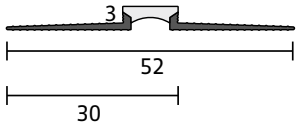

FP 52

- + unplasticised PVC-profile with a flexible expansion gap
- + wedge-shaped with adhesive furrows

ARTICLE 32623

packaging unit/length

20 pcs per 2.5 m = 50 m

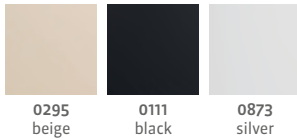

0295
beige

0111
black

0873
silver

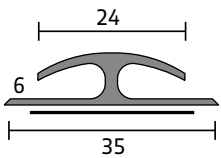

EFS 24/35/6 SK

- + plasticised PVC-double-edge-stair-nosing for floors up to 6 mm
- + selfadhesive
- + REACH compliant

ARTICLE 25918

packaging unit/length

10 pcs per 0.9 m = 9 m



0119
grey

0295
beige

SPECIAL-PROFILES

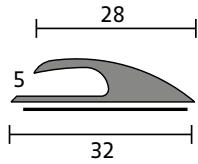

EFS 28/32/5 SK

- + plasticised PVC-edge-stair-nosing to use with floors up to 5 mm
- + selfadhesive
- + REACH compliant

ARTICLE 25957

packaging unit/length

10 pcs per 0.9 m = 9 m



0119
grey

0295
beige

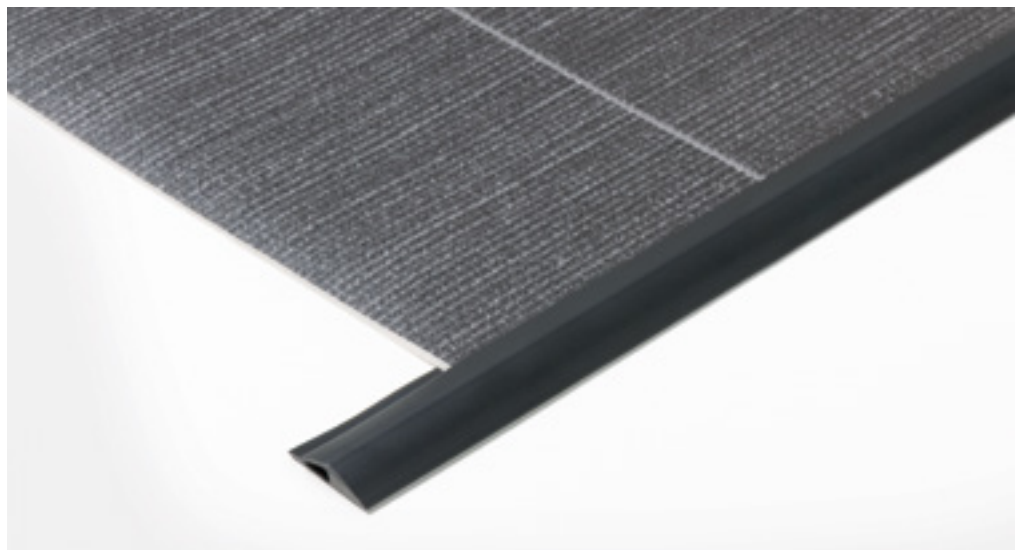
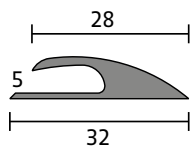

EFS 28/32/5

- + plasticised PVC-edge-stair-nosing to use with floors up to 5 mm
- + REACH compliant

ARTICLE 19357

packaging unit/length

1 roll per 25 m



0111
black

SPECIAL-PROFILES

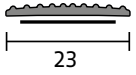

GS 23 SK

- + selfadhesive plasticised PVC-anti-slippering-profile for stair-nosings in 23 mm headway
- + REACH compliant

ARTICLE 20118

packaging unit/length
2 rolls per 50 m = 100 m



0111
black

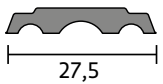
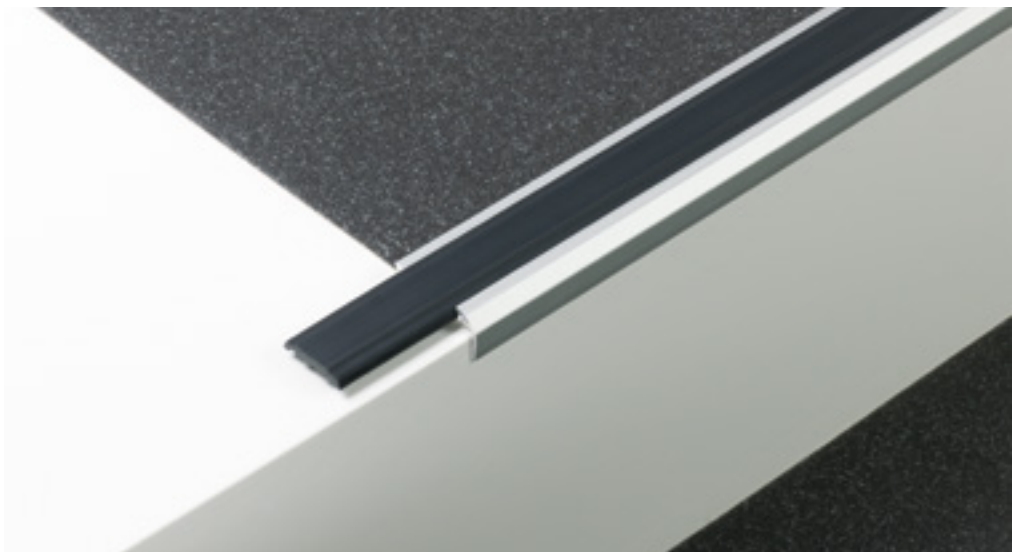

GS 27

- + plasticised PVC-inlay for anti slipping
- + REACH compliant

ARTICLE 20106

packaging unit/length
4 rolls per 25 m = 100 m



0111
black

SPECIAL-PROFILES

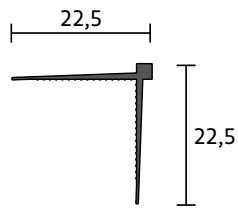

TEP 22

- + unplasticised edge-profile
- + to transfer wallpapers tidy and easy
- + adhesive furrow inside

ARTICLE 30230

packaging unit/length
15 pcs per 2,6 m = 39 m

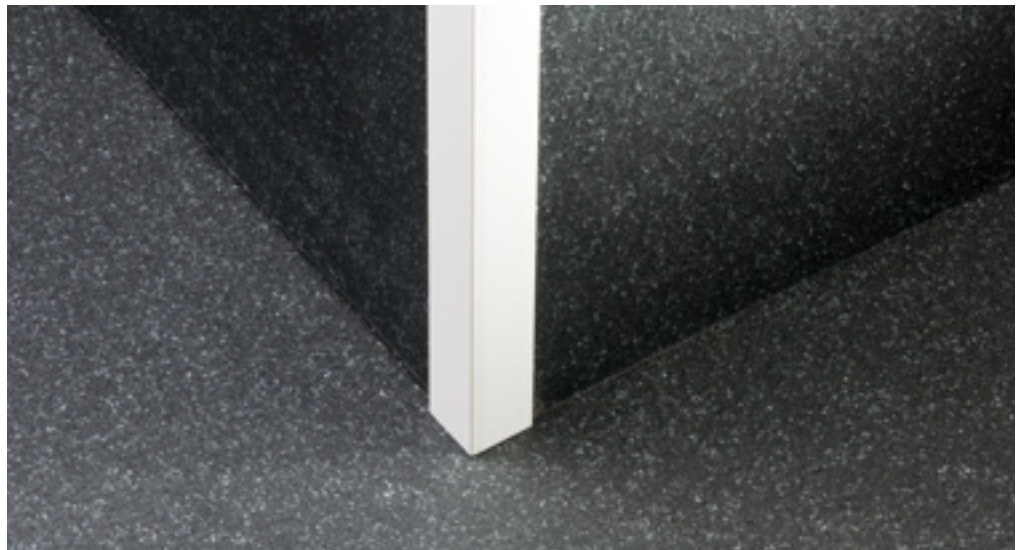
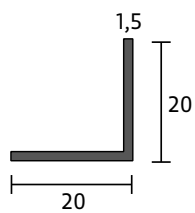

WL 20/20

- + unplasticised edge-profile
- + multi talent for edge protection at doors and window sills or only for decoration

ARTICLE 30121

packaging unit/length
20 pcs per 2.5 m = 50 m



SPECIAL-PROFILES

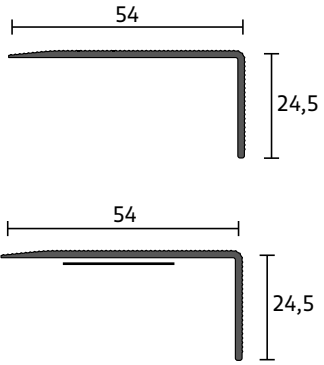

STW 54

+ level-angles, ideal for carpets in 54 mm headway

ARTICLE 32110

packaging unit/length
30 pcs per 2.7 m = 81 m



mixed color

STW 54 SK

+ level-angles, ideal for carpets in 54 mm headway
+ selfadhesive

ARTICLE 32510

packaging unit/length
30 pcs per 2.7 m = 81 m



mixed color

SPECIAL-PROFILES

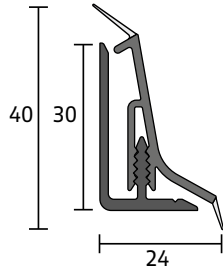

KL 40

- + unplasticised kitchen-end-skirting with girder section
- + damp proof
- + form-keeping

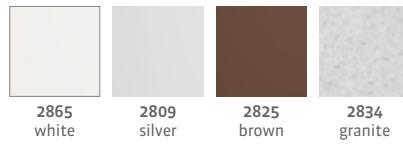

EQUIPMENT

colors

9901 granite gray	9909 silver
9925 brown	9965 white

ARTICLE 53025

packaging unit/length
5 units 10 packs

- + 5-unit-combi package with:
 - 1 internal and 1 external corner
 - 1 finish cap right and left
 - 1 connection

SPECIAL-PROFILES

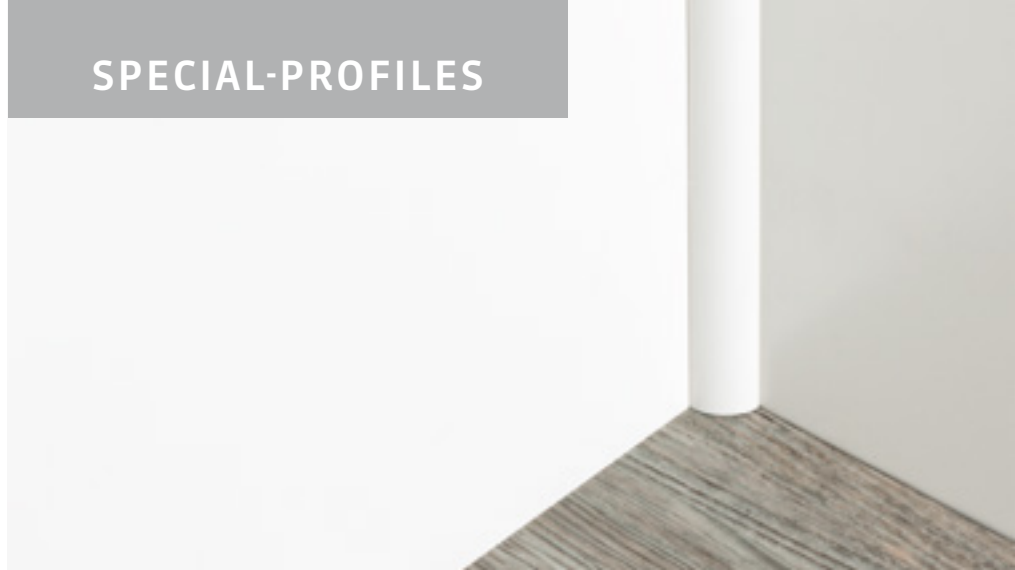
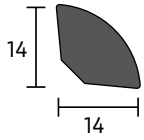

VST 14

- + PVC-hard-foam-coving width 14 mm x 14 mm
- + not affected by humidity

ARTICLE 25585

packaging unit/length
20 pcs per 2.5 m = 50 m



0101
white

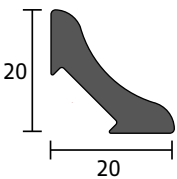

VST 20

- + PVC-hard-foam coving width 20 mm x 20 mm
- + not affected by humidity

ARTICLE 25586

packaging unit/length
20 pcs per 2.5 m = 50 m



0101
white

SPECIAL-PROFILES

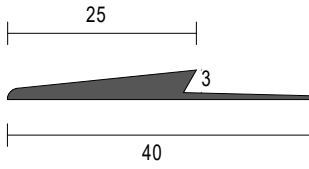

UEL 40

+ plasticised PVC- panel frame
+ REACH compliant

ARTICLE 20361

packaging unit/length

1 roll per 25 m



0111
black

Make your work easier

If you want to produce high quality in the process of fixing skirtings, work with our scheduled BOLTA-tool.

The BOLTA-punch is used for all hard-foam-skirtings to notch internal and external corners without gaps. Take our BOLTA-scissors for clear and straight cuts.

BOLTA-hot glue gun

Can be used for all hard foam skirting boards.

The hot glue gun is supplied in the assembly case and with three different nozzle attachments.



BOLTA-hot glue gun

ARTICLE 22300



BOLTA-hot glue sticks

ARTICLE 22350

18/300 mm

content per box: 5 kg – appx. 70 pcs



BOLTA-scissors

ARTICLE 22205

scissors leverage with 90 degrees for accurate cuttings



two-component-mastic

ARTICLE 22002

recoated- and paintable packing unit:

6 cans per 2 kg, 1 carton = 12 kg

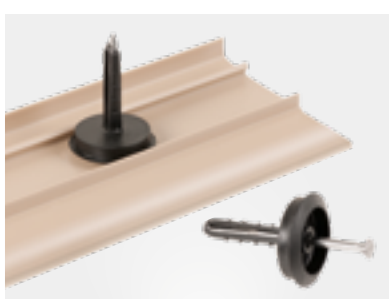

clip

ARTICLE 22025 + 22026

dowel and nails
content per unit:
dowel: 1000 pcs
nails: 1500 pcs.



metal-clip

ARTICLE 22030

multiple mounting and de-mounting without problems
content per unit: 50 pcs

BOLTA-skirting-punching case

In our BOLTA-punching case you have everything you need:

- + BOLTA-skirting board punch
- + orange pressure piece for 5mm profiles
- + white pressure piece and white guide block for 12mm profiles
- + BOLTA-profile scissors
- + BOLTA-professional cutter knife
- + BOLTA-meter stick



The case is also empty available.

BOLTA-punching case
ARTICLE 22240 (FILLED)

BOLTA-punching case
ARTICLE 22250 (EMPTY)

BOLTA-skirting board punch

Our BOLTA-skirting board punching machine is characterized by:

- + Integrated quick change system (5 and 12 mm thickness of the strips)
- + Markings for internal and external corner n
- + Better visibility to the working area



BOLTA-SL punch

ARTICLE 22251
for 5mm profiles



BOLTA-SL punch

ARTICLE 22252
for 12mm profiles

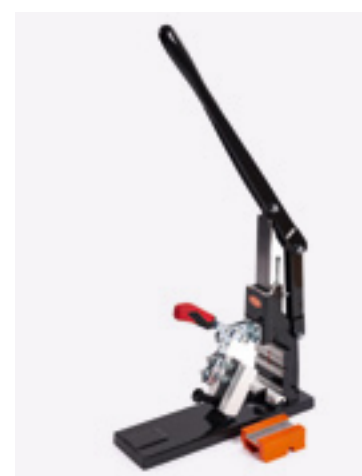

BOLTA-SL punch

ARTICLE 22253
for 5 + 12mm profiles



BOLTA-SL punch

ARTICLE 22257
for 16mm profiles



new

**BOLTA-ConversionSET
for 16mm profiles**

ARTICLE 22258

Towards our environment

We understand the principle of a sustainable resource-efficient business management as a major component of our forward-looking corporate policy. Our certified quality management system achieves a continuous minimization of environmental impacts and guarantees the highest possible protection of our employees. Our contribution to environmental protection are measures for heat recovery, a closed cooling water circuit as well as the reduction of waste through extensive recycling and systematic identification and implementation of energy conservation.

As we set special focus on an internal environmental program, we had achieved the continuous reduction of hazardous substances in our products, a complete waiver of toxic ingredients and the greatest possible elimination of substances of the current SVHC-list according to REACH. Concerning our story requirements on eco-and user-friendly products, we exceed the legal level, which only dictates declaration and authorization statements for a number of toxins.



APU

APU Schönberg GmbH
Industriestraße 1
94513 Schönberg, Germany

Phone +49 (0)8554 - 309-0
Fax +49 (0)8554 - 309-50
info@apu-schoenberg.de
www.apu-schoenberg.de

