



WSZYSTKO DO OGRODU

EVERYTHING FOR THE GARDEN
ВСЕ ДЛЯ САДУ

2023/2024



NEO
TOOLS

VERTO



NEO TOOLS

RELIABLE QUALITY AND TECHNOLOGY
NIEZAWODNA JAKOŚĆ I TECHNOLOGIA
НАДІЙНА ЯКІСТЬ І ТЕХНОЛОГІЯ



Garden tools that appear in the NEO TOOLS brand are a response to the expectations of brand followers and demanding users who also perform garden works. NEO garden products are characterized by durability, precision and high quality.

Narzędzia do ogrodu, które pojawiają się w marce NEO TOOLS stanowią odpowiedź na oczekiwania zwolenników marki oraz wymagających użytkowników, którzy wykonują również prace ogrodowe. Produkty ogrodowe NEO charakteryzuje wytrzymałość, precyzja wykonania oraz wysoka jakość.

Садові інструменти, які представлені маркою NEO TOOLS, є відповіддю на очікування прихильників марки та вимогливих користувачів, які виконують також і садові роботи. Садові інструменти NEO відрізняються довговічністю, прецизійністю виконання та високою якістю.

* Selected NEO TOOLS products feature a 25-year warranty and a TÜV M + T (Monitoring + Testing) certificate – you can find details at neo-tools.com

* 25 lat Gwarancji oraz certyfikat TÜV M + T (Monitoring + Testing) posiadają wybrane produkty NEO TOOLS – szczegóły na stronie neo-tools.com

* 25 років гарантії та список сертифікованих продуктів NEO TOOLS доступний на ua.neo-tools.com



VERTO

THERE IS SO MUCH TO DO
JEST TYLE DO ZROBIENIA
ТАК БАГАТО ТРЕБА ЗРОБИТИ



VERTO is:

- wide range of products for use at home, garden and in workshop
- versatile, convenient solutions with very good quality to price ratio
- products perfectly fit to moderate load

VERTO to:

- szeroka gama produktów do stosowania w domu, ogrodzie oraz warsztacie
- wszechstronne, wygodne w obsłudze rozwiązania w bardzo dobrej relacji jakości do ceny
- produkty idealnie sprawdzające się przy średnich obciążeniach

Verto це:

- широкий асортимент товарів для роботи в домі, на городі та в майстерні
- універсальні, прості у використанні, з дуже хорошим співвідношенням ціни та якості
- вироби ідеальні для середніх навантажень



vertotools.com



SYSTEMY WODNE
WATER SYSTEMS
СИСТЕМИ ВОДОПОСТАЧАННЯ



SYSTEMY WODNE

Systemy wodne

Regularne podlewanie ogrodu w sezonie jest konieczne, aby rośliny rozwijały się prawidłowo. Odpowiednio nawodniona murawa wygląda estetycznie i zachowuje zdrowy, zielony kolor.

W naszej bogatej ofercie znajduje się wiele urządzeń i akcesoriów, dzięki którym nawadnianie ogrodu jest przyjemne, szybkie i proste.

Oferta zawiera zraszacze pistoletowe regulowane, zraszacze proste, oscylacyjne, opryskiwacze ciśnieniowe, wózki i stojaki do węży oraz akcesoria: złączki, przyłącza, wyłączniki czasowe, wieszaki ścienne na węże.

Zapoznaj się z naszą ofertą!

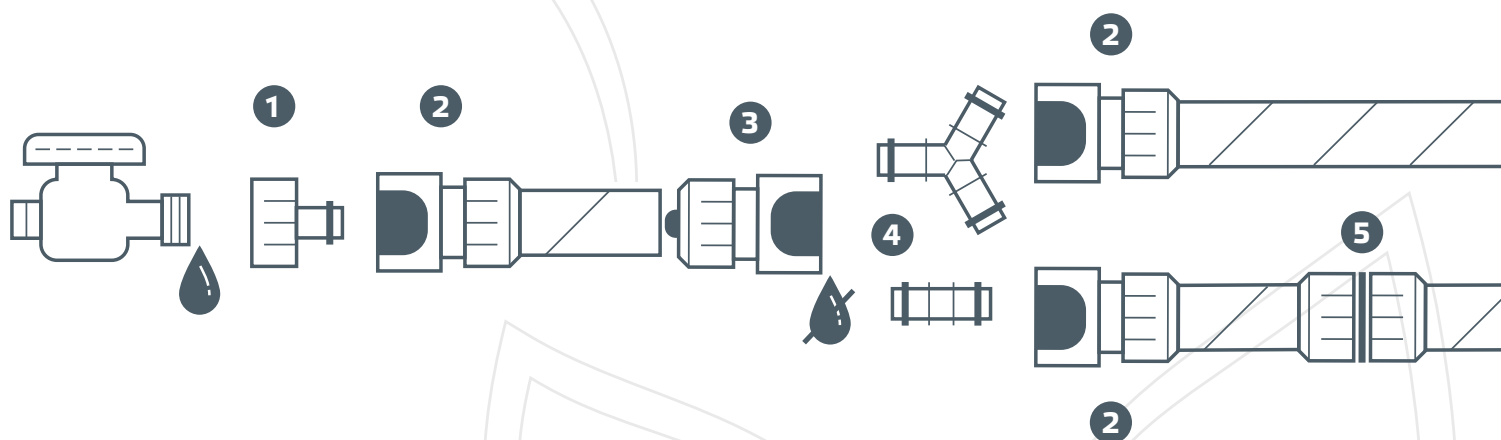

Water systems

Watering the garden regularly in the season is necessary for correct development of plants. Properly watered turf has aesthetical look and maintains healthy, green colour.

Comprehensive our offer includes many devices and accessories that will make garden watering a pleasant, quick and easy task.

The offer covers adjustable spray guns, straight water spray nozzles, oscillating sprinklers, pressure sprayers, trolleys and stands for hoses and accessories: couplers, connectors, watering timers, wall hooks for hose.

Check out our offer!

Системи водопостачання

Регулярний полив саду протягом сезону необхідний для правильного розвитку рослин. Правильно политий газон виглядає естетично і зберігає здоровий зелений колір.

У нашій широкій пропозиції є багато пристроїв і аксесуарів, які роблять полив вашого саду приємним, швидким і простим.

Пропозиція широко представляє регульовані пістолетні спринклери, прямі та осцилювані спринклери, розпилювачі під тиском, візки та підставки для шлангів, а також аксесуари: з'єднувачі, перехідники, таймери, настінні кріплення для шлангів.

Познайомтеся з нашою пропозицією!

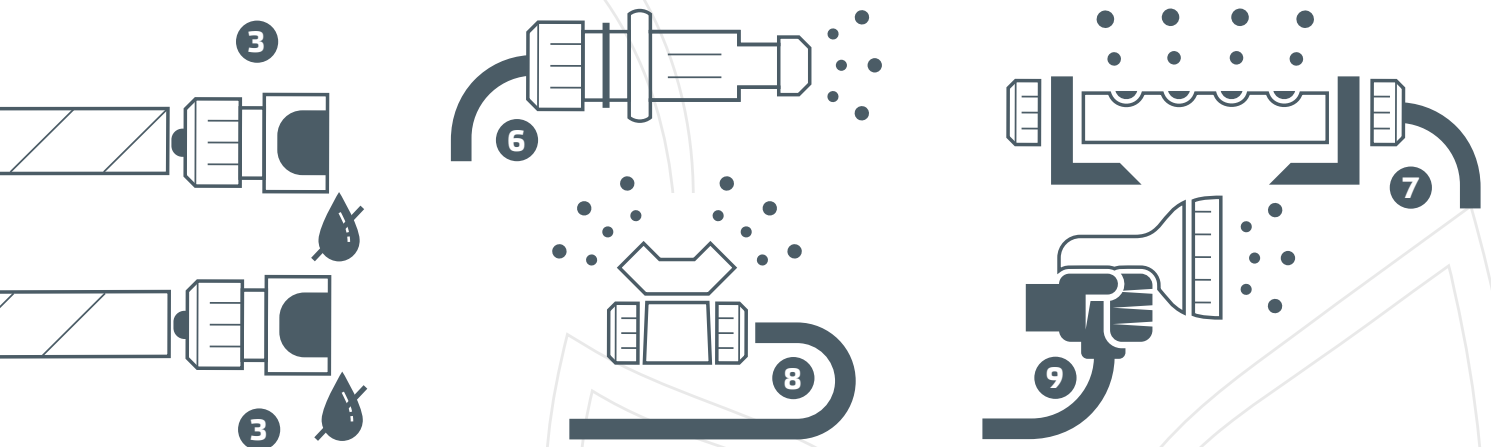

Wąż ogrodowy

Garden hose / Gartenschlauch / Шланг садовый / Шланг садовый / Kerti tömlő / Furtun de gradina / Zahradní hadice / Záhradná hadica / Vrtna cev / Sodo žarna / Dārza šļūtene / Aiavoolik / Градински маркуч / Crijevo za vrt / Baštensko crevo / Λόστιχο κήπου / Manguera de jardín / Tubo da giardino / Tuinslang

NEO
TOOLS



PROFESSIONAL

6
LAYERS



15-840	1/2"	20 m		1/1
15-841	1/2"	30 m		1/1
15-842	1/2"	50 m		1/1
15-843	3/4"	20 m		1/1
15-844	3/4"	30 m		1/1
15-845	3/4"	50 m		1/1

30
bar max

+60°C
-25°C

UV
protected

Flex

ANTI
algae

FOOD
safe

TWIST
protection

NEO
TOOLS



OPTIMA

4
LAYERS



15-820	1/2"	20 m		1/1
15-821	1/2"	30 m		1/1
15-822	1/2"	50 m		1/1
15-823	3/4"	20 m		1/1
15-824	3/4"	30 m		1/1
15-825	3/4"	50 m		1/1

25
bar max

+60°C
-20°C

UV
protected

Flex

ANTI
algae

FOOD
safe

NEO
TOOLS



ECONOMIC

4
LAYERS

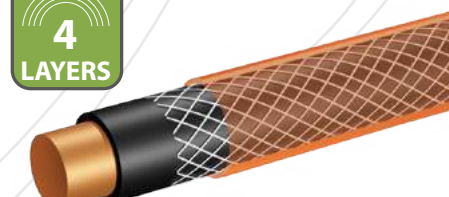

15-800	1/2"	20 m		1/1
15-801	1/2"	30 m		1/1
15-802	1/2"	50 m		1/1
15-803	3/4"	20 m		1/1
15-804	3/4"	30 m		1/1
15-805	3/4"	50 m		1/1

20
bar max

+50°C
-10°C

UV
protected

Flex

ANTI
algae

Wąż ogrodowy

Garden hose / Gartenschlauch / Шланг садовый / Шланг садовый / Kerti tömlő / Furtun de gradina / Zahradní hadice / Záhradná hadica / Vrtna cev / Sodo žarna / Dārza šļūtene / Aiavoolik / Градински маркуч / Crijevo za vrt / Baštensko crevo / Λόστιχο κήπου / Manguera de jardín / Tubo da giardino / Tuinslang

VERTO



OPTIMA

3
LAYERS



15G820	1/2"	20 m	☒	1/1
15G821	1/2"	30 m	☒	1/1
15G822	1/2"	50 m	☒	1/1
15G823	3/4"	20 m	☒	1/1
15G824	3/4"	30 m	☒	1/1
15G825	3/4"	50 m	☒	1/1

25
bar max

-10°C
+45°C

UV
protected

Flex

ANTI
algae

VERTO



ECONOMIC

3
LAYERS

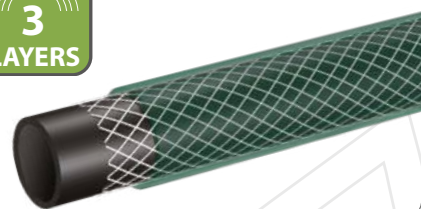

15G800	1/2"	20 m	☒	1/1
15G801	1/2"	30 m	☒	1/1
15G802	1/2"	50 m	☒	1/1
15G803	3/4"	20 m	☒	1/1
15G804	3/4"	30 m	☒	1/1
15G805	3/4"	50 m	☒	1/1

20
bar max

-5°C
+30°C

UV
protected

Flex

ANTI
algae

Wąż ogrodowy rozciągliwy

Flexible garden hose / Garten-Streckschlauch / Шланг садовый растягивающийся / Шланг садовый, що розтягується / Rugalmas kerti tömlő / Furtun de gradină extensibil / Elasticá zahradní hadice / Záhradná pružná hadica / Raztegljiva vrtna cev / Sodo žarna, išsitępianti / Izstiepiamā dārza šļūtene (izplešas laistīšanas laikā) / Pikendatav aiavoolik / Разтергателен градински маркуч / Elasticno vrtno crijevo / Elasticno baštensko crevo / Λόστιχο ποτίματος επεκτεινόμενο / Manguera de jardín flexible / Tubo elastico da giardino

VERTO



15G890 7.5 m - 22.5 m ☒ 1/8

12
bar

elastic

STREAM
CONTROL

TAP
CONNECTOR
1/2"-3/8"

Wąż z automatycznym zwijaczem

Hose with automatic retractor / Schlauch mit automatischem Retraktor / Шланг с автоматическим втягивающим устройством / Шланг з автоматичним втягувачем / Automata tömlődob / Furtun cu retractor automat / Hadice s automatickým navíječem / Hadica s automatickým navijačom / Cev z avtomatskim navijaalom / Žarna su automatinu įtraukikliu / Šļūtene ar automātisko spriegotāju / Automaatse tõmburiga voolik / Маркуч с автоматично прибиращо устройство / Crijevo s avtomatskim uvlačiteljem / Црево са аутоматским увлакачем / Σωλήνας με αυτόματο συσπειρωτήρα / Manguera con retractor automático / Tubo con riavvolgitore automatico / Mangueira com retrator automático / Tuyau avec enrouleur automatique / Slang met automatisch oprolmechanisme

NEO
TOOLS



15-891 1/2" 1/1



VERTO



15G891 1/2" 1/1



Wąż kroplujący

Soaker hose / Sprühschlauch / Шланг для капельного полива / Шланг для капельного поливу / Csepegető tömlő / Furtun de irigare prin picurare / Průsaková porézní zavlažovací hadice / Kvarkacia hadica / Kapljalna cev / Lašinio laistymo žarna / Pilienu šļūtene / Tilkvoolik / Маркуч за капкуване / Crijevo za navodnjavanje kap po kap / Cev prskalica / Σωλήνας άδρευσης / Manguera de goteo / Tubo per irrigazione / Mangueira de gotejamento / Tube goutte-à-goutte / Druppel slang

NEO
TOOLS



15-880 1/2" 1/12



Stojak do węża

Hose reel stand / Schlauchtrommel mit Gestell / Катушка для шланга на подставке / Стійка до шлангу / Tömőkocsi / Tambur pentru furtun / Stojan na hadici / Stojan na hadicu / Stojalo za cev / Stovas žarnai / Dārza slūtenes statīvs / Voolikhuidik / Макара за градински маркуч / Stalak za crijevo / Stalak za crevo / Καρούλι ποτίσματος επιδαπέδιο / Soporte para manguera / Anvolgitubo / Enrolador de mangueira / Support de dévidoir-enrouleur / Slanghaspel gemonteerd

NEO
TOOLS



15-790  1/4



METAL

DURABLE

FOLDABLE

100m
1/2"

30m
3/4"

PORTABLE

NEO
TOOLS



15-791  1/5



FOLDABLE

60m
1/2"

20m
3/4"

PORTABLE

VERTO



15G790  1/4



FOLDABLE

45m
1/2"

15m
3/4"

PORTABLE

Wózek do węży

Hose reel trolley / Schlauchwagen / Катуха для шланга на колесах / Візок для шлангу / Tömőkocsi / Cărucior suport pentru furtun / Vozík na hadici / Vozík na hadicu / Vozíček za cev / Žarný vozíček / Dārza šļūtenes ratiņi / Voolikukäru / Количка за градински маркуч / Kolicica za srijevu / Kolicica za crevo / Κορούλι ποτίσματος τροχήλατο / Carretilla para manguera / Carrello avvolgitubo / Carrinho enrolador de mangueira / Chariot de tuyau d'arrosage / Haspelkar

NEO
TOOLS



15-792  1/2

METAL

FOLDABLE

100m
1/2"

30m
3/4"

MOBILE

NEO
TOOLS



15-793  1/5

FOLDABLE

60m
1/2"

20m
3/4"

MOBILE

VERTO



FOLDABLE

45m
1/2"

15m
3/4"

MOBILE

15G791  1/6

Wieszak na wąż

Hose hanger / Wandschlauchhalter / Вешалка для поливочного шланга / Підвішувач для шлангу / Tömítőrtartó / Suport furtun / Závěs na hadici / Vešák na hadicu / Obešalnik za cev / Žarnos pakaba / Dārza šļūtenes turētājs / Vooliku riputuskonks / Стенна стойка за градински маркуч / Vješalica za crijevo / Vešalica za crevo / Βάση-Σέλα τοίχου για λάστιχο ποτίσματος / Colgador de manguera / Portatubo / Suporte de mangueira / Support de tuyau d'arrosage / Slangophang

VERTO



15G798  1/50

Prowadnica do węża rolkowa

Roller hose guide / Rollenschlauchführung / Роликовая направляющая для шланга / Направляюча роликового шланга / Görgös tömlővezető nyitott / Ghidaj furtun cu role / Vedení hadice válce / Vedenie hadice valčeka / Vodilo valjaste cevi / Ritinių žarnų kreiptuvas / Rullistu šļūtenes vadotne / Rullivooliku juht / Водач за ролкови маркучи / Vodič valjkastog crijeva / Водич ваљаног црева / Οδηγός εύκαμπτου σωλήνα / Guía de manguera de rodillo / Guida tubo a rullo / Guia da mangueira de rolo / Guide de tuyau à rouleau / Rolslanggeleider

VERTO



15G851  1/20



Prowadnica do węża zamknięta

Hose guide closed / Schlauchführung geschlossen / Направляющая шланга закрыта / Направляюча шланга закрыта / Görgös tömlővezető zárt / Ghidajul furtunului închis / Vedení hadice zavřené / Vedenie hadice zatvorené / Vodilo za cev je zaprto / Žarnos kreiptuvas uždarytas / Šļūtenes vadotne ir aizvērta / Voolikujuhik on suletud / Водачът на маркуча е затворен / Vodič crijeva zatvoren / Водич за црево затворен / Ο οδηγός σωλήνα έκλεισε / Guía de manguera cerrada / Guida del tubo chiusa / Guia de mangueira fechada / Guide de tuyau fermé / Slanggeleider gesloten

VERTO



15G852  6/24



Składany pojemnik na deszczówkę

Collapsible rainwater storage container / Zusammenlegbarer Regenwasser-Sammelbehälter / Складной контейнер для хранения дождевой воды / Розбірний контейнер для зберігання дощової води / Összecsukható esővíztároló tartály / Recipient pliant pentru depozitarea apei de ploaie / Skládací nádoba na dažďovú vodu / Skladacia nádoba na dažďovú vodu / Zlozljiva posoda za deževnico / Sulankstoma lietaus vandens talpykla / Salokāms lietus ūdens uzglabāšanas konteiners / Kokkurandav vihmavee mahuti / Съваем контейнер за съхранение на дъждовна вода / Sklopiva posuda za kišnicu / Склопиви контејнер за кишницу / Αναδιπλούμενο δοχείο αποθήκευσης βρόχινου νερού / Recipiente plegable para almacenar agua de lluvia / Contenitore pieghevole per l'acqua piovana / Recipiente para armazenamento de água da chuva dobrável / Conteneur pliable pour le stockage de l'eau de pluie

NEO TOOLS



15-951  1/6



250L

∅ 60cm

PVC

LIGHT WEIGHT

NEO TOOLS



15-952  1/4



500L

∅ 80cm

PVC

LIGHT WEIGHT

Zraszacz pistoletowy

Water spray gun / Ороситель пистолетный / Sprühpistole Spritze / Опрыскувач пистолетний / Öntöző pisztoly / Pistol de stropire / Postřikovací pistole / Pištoľový postrekovač / Brizgalna pištola / Purkštukas - pistoletas / Laistīšanas pistole / Pūstol-pihustusotsak / Пистолет струйник / Raspršivač na pištoli / Pištoli prskalica / Εκτοξευτής νερού πιστόλι / Aspersor tipo pistola / Irrigatore a pistola / Pistola de aspersão / Arroseur à pistolet / Spuitpistool



JET



CONE



MIST



CENTER



SOAKER



FLAT



SHOWER



STREAM



VERTICAL



Zraszacz pistoletowy

Water spray gun / Ороситель пистолетный / Sprühpistole Spritze / Опрыскивач пистолетний / Öntöző pisztoly / Pistol de stropire / Postřikovací pistole / Pištoľový postrekovač / Brizgalna pištola / Purkštukas - pistoletas / Laistīšanas pistole / Püistol-pihustusotsak / Пистолет струйник / Raspršivač na pištolj / Pištolj prskalica / Εκτοξευτής νερού πιστόλι / Aspersor tipo pistola / Irrigatore a pistola / Pistola de aspersão / Arroiseur à pistolet / Spuitpistool

NEO
TOOLS



15-706 12/48



VERTO



15G710 12/48

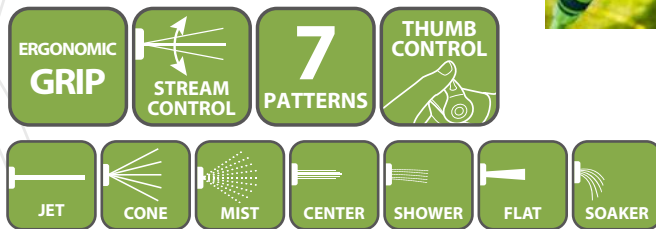

VERTO



15G707 12/24



VERTO



15G704 12/48



Zraszacz pistoletowy

Water spray gun / Ороситель пистолетный / Sprühpistole Spritze / Опрыскувач пистолетний / Öntöző pisztoly / Pistol de stropire / Postřikovací pistole / Pištoľový postrekoávač / Brizgalna pištola / Purkštukas - pistoletas / Laistīšanas pistole / Pūstol-pihustusotsak / Пистолет струйник / Raspršivač na pištoľ / Pištoľ prskalica / Εκτοξευτής νερού πιστόλι / Aspersor tipo pistola / Irrigatore a pistola / Pistola de aspersão / Arroser à pistolet / Spuitpistool

VERTO



15G702 12/48

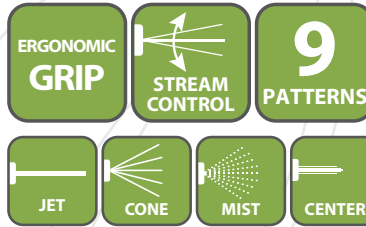

VERTO



15G717 1/48

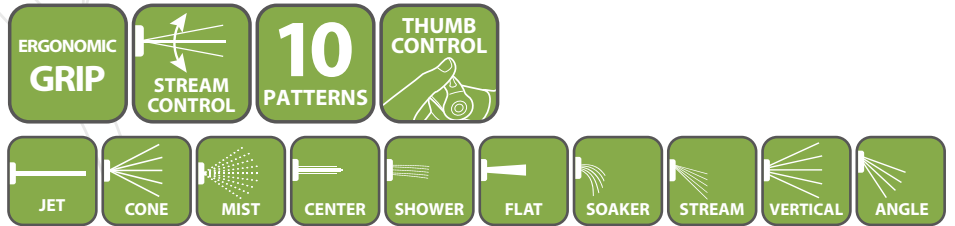

VERTO



15G714 1/48



NEO TOOLS



15-705 12/48

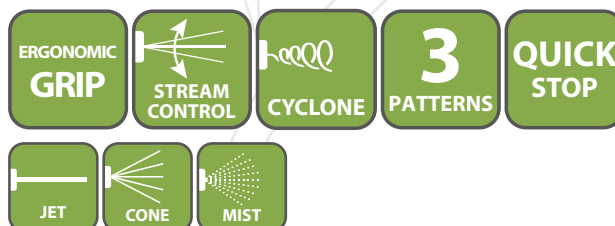

Zraszacz pistoletowy

Water spray gun / Ороситель пистолетный / Sprühpistole Spritze / Опрыскивач пистолетний / Öntöző pisztoly / Pistol de stropire / Postřikovací pistole / Pištoľový postrekovač / Brizgalna pištola / Purkštukas - pistoletas / Laistīšanas pistole / Püistol-pihustusotsak / Пистолет струйник / Raspršivač na pištolj / Pištolj prskalica / Εκτοξευτής νερού πιστόλι / Aspersor tipo pistola / Irrigatore a pistola / Pistola de aspersão / Arroser à pistolet / Spuitpistool

VERTO



15G706 12/48

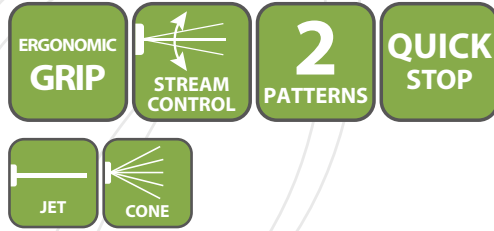

VERTO



15G703 12/48

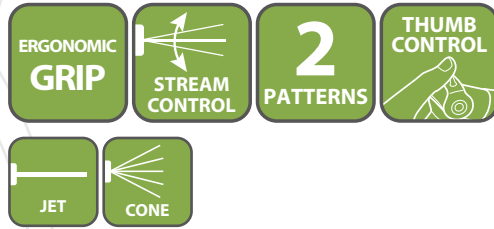

VERTO



15G716 1/48



VERTO



15G718 25/100



Zestaw ze zraszaczem pistoletowym

Gardening set with water spray gun / Набор пистолетным оросителем / Set mit Sprühpistole / Набор із пистолетним опрыскувачем / Öntözö pisztoly szett / Set cu pistol de stropire / Sada s postřikovací pistolí / Súprava pištoľov ým postrekovačom / Kompletz brizgalnopištoľo / Laistymokomplektassupurkštukupistoľetu / Kompleksartaisnolaistšanaspistolī / Tavalisepiistolotsakugakomplekt / Комплектспистолетструйник / Setsraspršivačemnapištoľ / Priborsapištoľjprskalicom / Σετμεκτοξευτήνερούπistolī / Setconaspersortipipistolā / Kitirrigatoreapistola / Kitcompistoladeaspersão / Ensemble d'arroseurà pistollet / Tuingereedschapsriem

VERTO



15G713 10/50



VERTO



15G712 6/48



Zestaw ze zraszaczem prostym

Gardening set with straight nozzle / Набор с прямым оросителем / Set mit Sprühregner / Набор із прямим зрошувачем опрыскувачем / Öntözö fej szett / Set cu spritzer de strop / Sada s postřikovačem na hadici / Súprava s jednoduchým postrekačom / Komplet z ravno brizgalko / Laistymo kompletas su tiesiu purkštuku / Komplekts ar taisno laistīšanas uzgali / Tavalise otsakuga komplekt / Комплект с прав струйник / Set s običnim raspršivačem / Pribor sa običnom prskalicom / Σετ με εκτοξευτή νερού λόγχη / Set con aspensor recto pistola / Kit irrigatore dritto / Kit com agulheta / Ensemble d'arroseur simple / Set met spuitpistool

NEO
TOOLS



15-710  12/48

1/2"



BIMATERIAL



NEO
TOOLS



15-711  12/48

3/4"



BIMATERIAL



VERTO



15G711  12/48

1/2"



BIMATERIAL



VERTO



15G699  1/48

1/2"



Zraszacz prosty

Straight water spray nozzle / Sprühregner / Ороситель прямой / Зрошувач прямий / Öntöző fej / Spritzer stropit / Postřikovač na hadici / Jednoduchý postrekovač / Ravna brizgalka / Tiesus purkštukas / Laistīšanas uzgalis (taisns) / Tavaline pihustusotsak / Прав струйник / Obični raspršivač / Obična prskalica / Εκτοξευτής νερού λόγχη / Aspersor recto / Irrigatore dritto / Agulheta de aspersão / Arroseur simple / Spuitpistool

NEO
TOOLS



15-700 12/48



VERTO



15G701 10/50



VERTO



15G700 12/48



VERTO



15G698 1/200



Zraszacz pistoletowy

Water spray gun / Ороситель пистолетный / Sprühpistole Spritze / Опрыскавач пистолетний / Öntözőpisztoly tartályos / Pistol de stropire / Postřikovací pistole / Pištoľový postrekovač / Brizgalna pištola / Purkštukas - pistoletas / Laistīšanas pistole / Püistol-pihustusotsak / Пистолет струйник / Raspršivač na pištolj / Pištolj prskalica / Εκτοξευτής νερού πιστόλι / Aspersor tipo pistola / Irrigatore a pistola / Pistola de aspersão / Arroseur à pistolet / Spuitpistool

VERTO



15G715 6/24



Lanca zraszająca

Spray lance / Sprühlanze / Распылитель / Розпилювач / Permetező lándzsa / Lance de stropit / Postřikovací tyč / Rozprašovacie kopije / Razpršilna palica / Purkštukas / Izsmidzināšanas lance / Pihustustu / Разпръсквач / Prskalica / Прскалица, телескопска / Μακρός ψεκαστήρας / Lanca pulverizadora / Lancia a spruzzo / Lança de pulverização / Lance de pulvérisation / Spuitlans

VERTO



15G681 40 cm 1/24



VERTO



15G682 77 - 113 cm 1/24



Prysznic ogrodowy

Garden shower / Gartendusche / Душ в саду / Садовый душ / Kerti zuhanyzó / Duš de grădină / Zahradní sprcha / Záhradná sprcha / Vrtni tuš / Sodo dušas / Dārza duša / Aia dušš / Градински душ / Vrtni tuš / Баштенски туш / Ντους κήπου / Ducha de jardín / Doccia da giardino / Duche de jardin / Douche de jardin / Tuindouche

VERTO

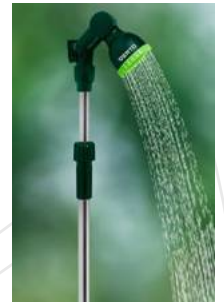

15G685 160 - 230 cm 1/10



Zraszacz oscylacyjny

Oscillating sprinkler / Rasensprenger / Дождеватель маятниковый / Зрошувач осциляційний / Billenő öntöző / Aspersor oscilant / Oscilační postřikovač / Oscilačný postrekoč / Nihajni zalivalnik / Svytuoklinis purkštukas / Dārza laistītājs / Pöörlev pihustusotsak / Осцилиращ разпръсквач / Oscilirajući raspršivač / Oscilatorna prskalica / Ποτιστικό βεντάλια σπρίνκλερ / Aspersor oscilante / Irrigatore oscillante / Arroseur oscillant / Slanghaspel gemonteerd

NEO
TOOLS



15-772  1/6

METAL

DURABLE

20
NOZZLES

ANGLE
ADJUSTMENT

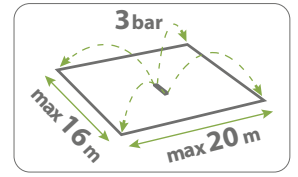
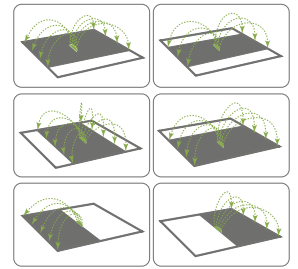

NEO
TOOLS



15-771  1/6

METAL

18
NOZZLES

ANGLE
ADJUSTMENT

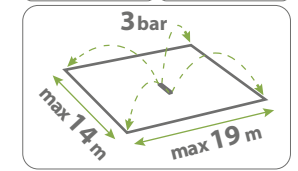
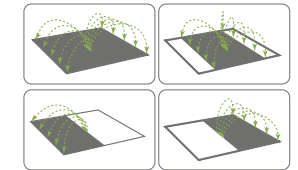

VERTO



15G772  4/8

18
NOZZLES

ANGLE
ADJUSTMENT

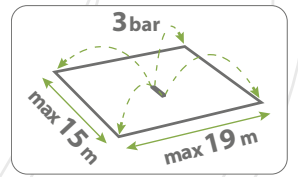

VERTO



15G771  1/8

METAL

16
NOZZLES

ANGLE
ADJUSTMENT

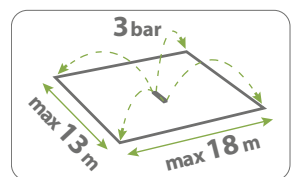

Zraszacz oscylacyjny

Oscillating sprinkler / Rasensprenger / Дождеватель маятниковый / Зрошувач осциляційний / Billenő öntöző / Aspersor oscilant / Oscilační postřikovač / Oscilačný postrekovač / Nihajni zalivalnik / Svytuoklinis purkštukas / Dārza laistītājs / Põõrlev pihustusotsak / Осцилиращ разпръсквач / Oscillirajući raspršivač / Oscilatorna prskalica / Ποτιστικό βεντάλια σπρίνκλερ / Aspersor oscilante / Irrigatore oscillante / Aspersor oscilante / Arroseur oscillant / Slanghospel gemonteerd

VERTO



15G770 10/20

16
NOZZLES

ANGLE
ADJUSTMENT

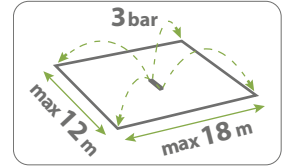

VERTO



15G773 6/12

16
NOZZLES

ANGLE
ADJUSTMENT



78
m²

0-360°

15G785 1/6



Zraszacz ogrodowy

Garden sprinkler / Gartensprenger / Ороситель садовый / Опрысквач садовый / Kerti locsoló / Sprinkler de grădină / Zahradní postřikovač / Záhradný postrekovač / Vrtni zalivalnik / Sodo purkštukas / Dārza laistītājs / Aiapihusti / Градинска пръскачка / Orošivač za vrt / Prskalica za baštu / Εκτοξευτήρας κήπου / Aspersor de jardín / Irrigatore da giardino

NEO
TOOLS



15-780 4/24

METAL

120
m²

9
PATTERNS



VERTO



15G780 1/6

120
m²

8
PATTERNS



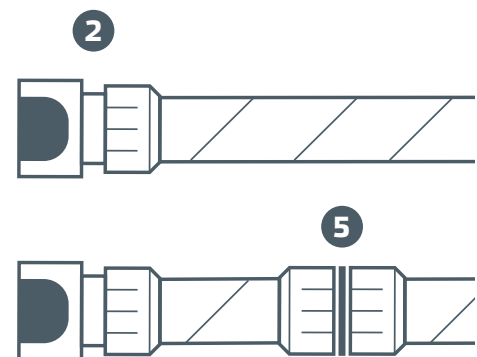
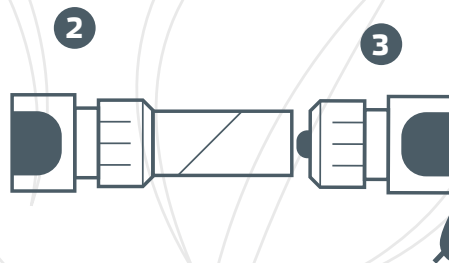
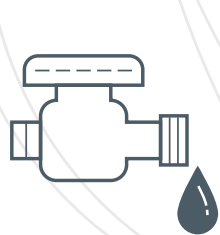

Przyłącze do kranu

Hose tap connector / Hahnstück / Адаптер на кран / Адаптер до крану / Csapcsatlakozó / Adaptor robinet / Přípojka na kohoutek / Přípojka na vodovod / Priključek za pipo / Čiaupo jungtis / Krāna tīcaurules / Kraaniühendus / Адаптор за кран / Priključak za slavinu / Priključak za slavinu / Ρακόρ για βρύση / Conector para grifo / Adattatore per rubinetto / União de torneira / Ajustage de robinet / Kraanverbindstuk



15-746 12/48

NEO TOOLS

BRASS
1/2"-3/4" 3/4"-1"



15-747 12/48

Złączka

Connector / Kupplung / Соединитель / З'єднувальний елемент / Csatlakozó / Manşon / Spojka / Spřájací článok / Spojka / Jungtis / Savienotājs / Ühendused / Myfa / Klema / Spojka / Σύνδεσμος / Conector / Raccordo / União / Raccord / Spröeier



15-730 12/48

NEO TOOLS

BRASS
1/2" QUICK CONNECT 3/4"

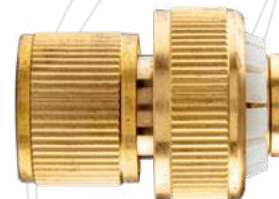

15-732 12/48

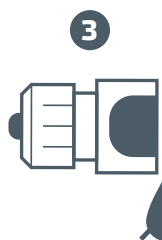

15-731 12/48

NEO TOOLS

BRASS
1/2" QUICK CONNECT STOP 3/4"



15-733 12/48

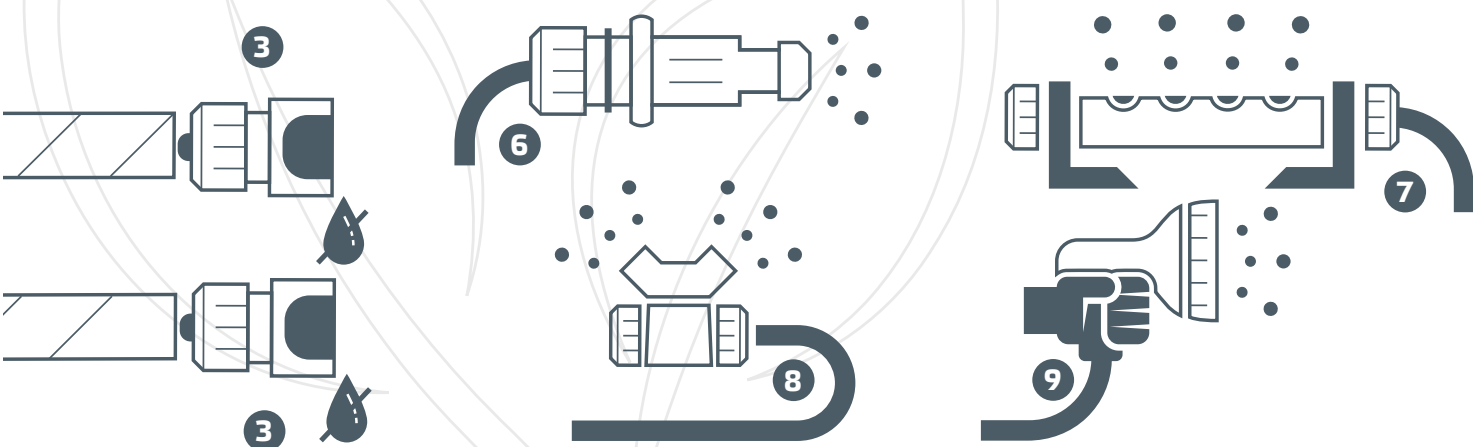

Rozdzielacz typu Y

3 way hose connector / Y-Schlauchverteiler / Тройник / Сепаратор-трийник / 3-utas csatlakozó / Conector extensie triplu / Y-kus / Rozdeľovač typ Y / Razdelilnik tipa Y / Trišakis greito jungimo laistymo žarnoms sujungti, Y tipo / Y tipa sadalītājs / Y-tüüpi jaotur / Тройник за бързи връзки / Y razvodnik / Razdelnik tipa Y / Σύνδεσμος τριών ταχυσυνδέσμων / Derivación tipo Y triple / Raccordo a Y / União em Y / Répartiteur de type Y / 3-weg stuk Y

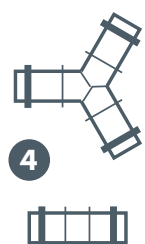

15-748 12/48



NEO TOOLS

BRASS

Złącze typu I

2 way connector / Schlauchverbinder gerade / Двойник / З'єднувач типу I / Tömlő összekötő csatlakozó / Cupla furtun / Hadicová spojka / Spojka typ I / Dvojni priključek za cev / Jungtis laistymo žarnoms sujungti, I tipo / I tipa savienotāji / I-tüüpi ühendus / Съединител за бърза връзка / Spoj tipa I / Priključak tipa I / Σύνδεσμος δύο ταχυσυνδέσμων / Conector tipo I / Raccordo dritto / União em I / Connecteur raccord de type I / 1-weg stuk I



15-749 12/48



NEO TOOLS

BRASS

Reparator do węża

Hose repair connector / Schlauchverbinder / Универсальная ремонтная муфта / Репаратор до шлангу / Tömlőfordó javító / Cupla imbinare furtun / Hadicová oprávka / Hadicová spojka / Reparator za cev / Jungtis žarnai / Remontuzmava dārza šļūtenei / Vooliku parandamise ühendus / Муфта-соединитель за маркуч / Reparator za crljevo / Reparator za crevo / Σύνδεσμος για ένωση δύο λάστιχων / Reparador de manguera / Raccordo riparatore / Reparador de mangueira / Réparateur de tuyau / Knelkoppeling



15-736 12/48



NEO TOOLS

1/2" BRASS 3/4"



15-737 12/48

Szybkozłączka

Quick coupler / Schnellkupplungen / Быстросменная муфта / Муфта швидкорознімна / Pneumatikus gyorscsatlakozó / Conector rapid / Rychlospojka / Rýchlospojka / Hitra spojka / Greitoji jungtis / Ātrsavienotājs / Kiirühendus / Бърза връзка / Spojnica / Brzo odvajanje / Συζευκτήρας ταχείας απελευθέρωσης / Acoplador rápido / Connettore rapido con presa per tubo / União rápida / Rapport rapide / Snelkoppeling



NEO TOOLS

BRASS



15-620	1/2"		10/60
15-622	3/4"		10/60
15-623	1"		10/60
15-624	1 1/4"		10/60

15-632	1"		10/60
15-633	1 1/4"		10/60
15-642	1"		10/60

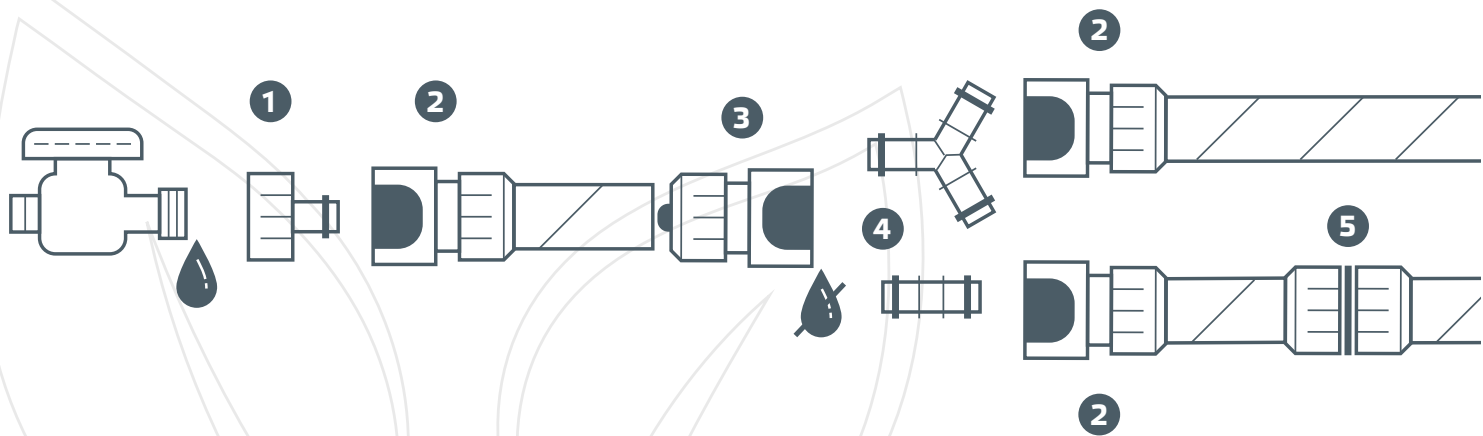

Przyłącze do kranu

Hose tap connector / Hahnstück / Адаптер на кран / Адаптер до крану / Csapcsatlakozó / Adaptor robinet / Přípojka na kohoutek / Přípojka na vodovod / Priključek za pipo / Čiaupo jungtis / Krāna tsaucurules / Kraaniühendus / Адаптор за кран / Priključak za slavinu / Priključak za slavinu / Παράρ για βρύση / Conector para grifo / Adattatore per rubinetto / União de torneira / Ajudage de robinet / Kraanverbindstuk

NEO
TOOLS



15-740 12/96



15-741 12/96

Złącza

Connector / Kupplung / Соединитель / З'єднувальний елемент / Csatlakozó / Manşon / Spojka / Spájací článok / Spojka / Jungtis / Savienotājs / Ühendused / Μυφα / Klema / Spojka / Σύνδεσμος / Conector / Raccordo / União / Raccord / Spreier

NEO
TOOLS

2



15-720 12/96



15-722 12/96

NEO
TOOLS

3



15-721 12/96



15-723 12/96

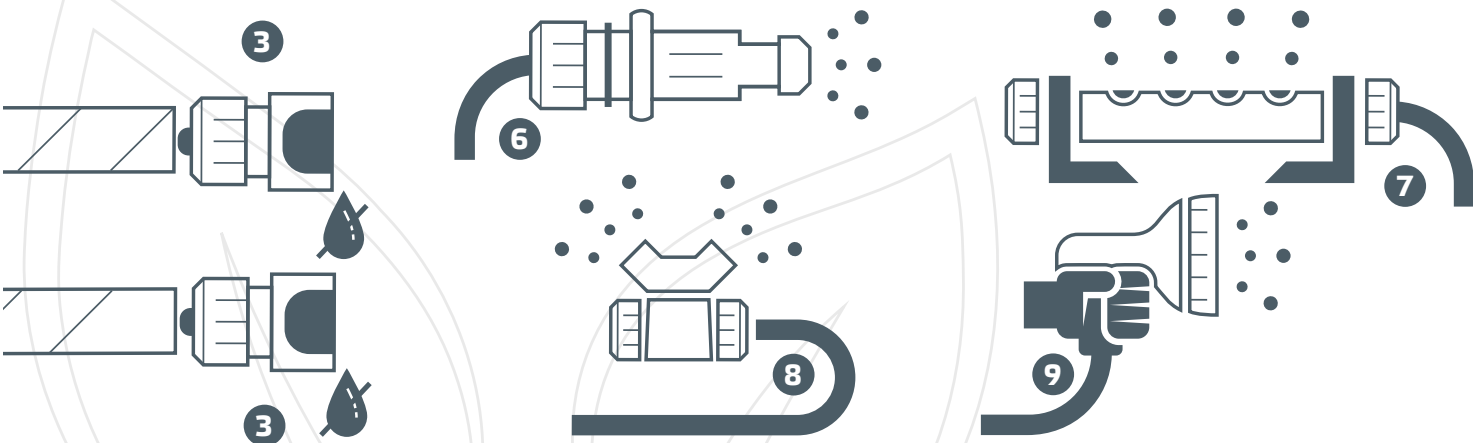

Rozdzielacz typu Y

3 way hose connector / Y-Schlauchverteiler / Тройник / Сепаратор-тройник / 3-utas csatlakozó / Conector extensie triplu / Y-kus / Rozdeľovač typ Y / Razdelilnik tipa Y / Trišakis greito jungimo laistymo žarnos sujungti, Y tipo / Y tipa sadalītājs / Y-tüüpi jaotur / Тройник за бързи връзки / Y razvodnik / Razdelnik tipa Y / Σύνδεσμος τριών ταχυσυνδέσμων / Derivación tipo Y triple / Raccordo a Y / União em Y / Répartiteur de type Y / 3-weg stuk Y

Złącze typu I

2 way connector / Schlauchverbinder gerade / Двойник / З'єднувач типу I / Tömlő összekötő csatlakozó / Cupla furtun / Hadicová spojka / Spojka typ I / Dvojní priključek za cev / Jungtis laistymo žarnos sujungti, I tipo / I tipa savienotāji / I-tüüpi ühendus / Съединител за бърза връзка / Spoj tipa I / Priključak tipa I / Σύνδεσμος δύο ταχυσυνδέσμων / Conector tipo I / Raccordo dritto / União em I / Connecteur raccord de type I / 1-weg stuk I

NEO TOOLS

BIMATERIAL

NEO TOOLS

BIMATERIAL

Reparator do węzła

Hose repair connector / Schlauchverbinder / Универсальная ремонтная муфта / Ремонтатор до шлангу / Tömlőoldó javító / Cupla imbinare furtun / Hadicová oprávka / Hadicová spojka / Reparatör za cev / Jungtis žarnai / Remontuzmava dārza šļūtenei / Vooliku parandamise ühendus / Муфа-съединител за маркуч / Reparatör za crijevo / Reparatör za crevo / Σύνδεσμος για ένωση δύο λάστιχων / Reparador de mangueira / Raccordo riparatore / Reparador de mangueira / Réparateur de tuyau / Knellkoppeling

NEO TOOLS

1/2" BIMATERIAL

NEO TOOLS

3/4" BIMATERIAL



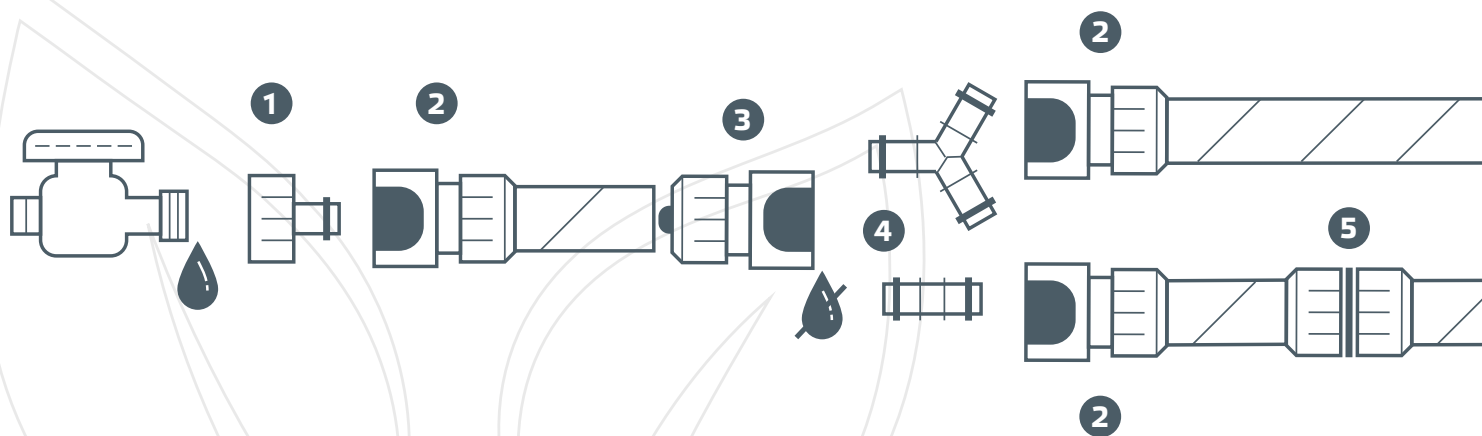

Przyłącze do kranu

Hose tap connector / Hahnstück / Адаптер на кран / Адаптер до крану / Csapcsatlakozó / Adaptor robinet / Přípojka na kohoutek / Přípojka na vodovod / Priključek za pipo / Čiaupo jungtis / Krāna īscaurules / Kraaniühendus / Адаптор за кран / Priključak za slavinu / Priključak za slavinu / Πακόρ για βρύση / Conector para grifo / Adattatore per rubinetto / União de torneira / Ajutage de robinet / Kraanverbinstuk



VERTO

x1



x30

15G740 12/96



15G740-30 1/6

Złączka

Connector / Kupplung / Соединитель / З'єднувальний елемент / Csatlakozó / Manşon / Spojka / Spájací článok / Spojka / Jungtis / Savienotājs / Ühendendus / Myfa / Klema / Spojka / Σύνδεσμος / Conector / Raccordo / União / Raccord / Spreier

2



VERTO

BIMATERIAL

1/2''

x1

3/4''

15G730 20/240



15G732 20/240

2



VERTO

BIMATERIAL

1/2''

x30

3/4''

15G730-30 1/4



15G732-30 1/4

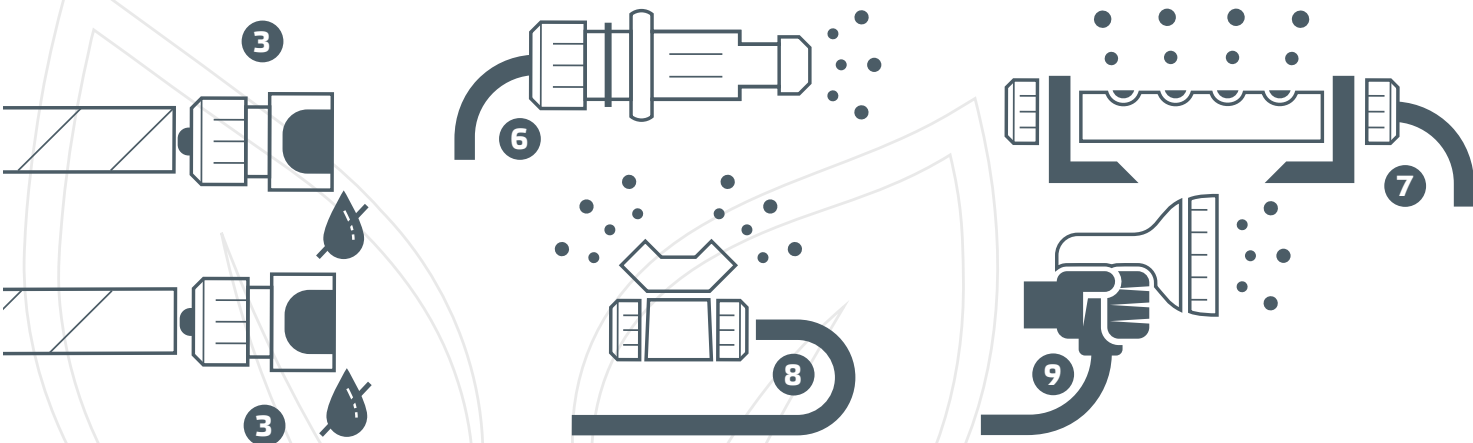

Złączka

Connector / Kupplung / Соединитель / З'єднувальний елемент / Csatlakozó / Manşon / Spojka / Spájací článok / Spojka / Jungtis / Savienotājs / Ühendused / Μυφα / Klema / Spojka / Σύνδεσμος / Conector / Raccordo / União / Raccord / Sproeier

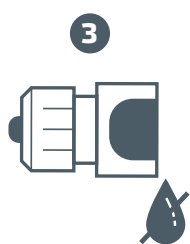

15G731 20/240

VERTO

BIMATERIAL

STOP

1/2"

x1

3/4"



15G733 20/240

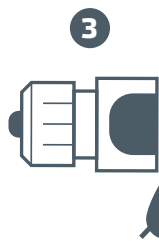

15G731-30 1/6



VERTO

BIMATERIAL

STOP

1/2"

x30

3/4"



15G733-30 1/6



Reparator do węża

Hose repair connector / Schlauchverbinder / Универсальная ремонтная муфта / Репаратор до шлангу / Tömlötoldó javító / Cupla imbinare furtun / Hadicová oprávka / Hadicová spojka / Reparatör za cev / Jungtis žarnai / Remontuzmava dārza šļūtenei / Vooliku parandamise ühendus / Μυφα-σύνδεσμος / Reparatör za crijevo / Reparatör za crevo / Σύνδεσμος για ένωση δύο λάστιχων / Reparatör de manguera / Raccordo riparatore / Reparatör de mangueira / Réparateur de tuyau / Knelkoppeling



15G746 20/240

VERTO

BIMATERIAL

1/2"

3/4"



15G747 20/240

Przyłącze do kranu

Hose tap connector / Hahnstück / Адаптер на кран / Адаптер до крану / Csapcsatlakozó / Adaptor robinet / Přípojka na kohoutek / Přípojka na vodovod / Priključek za pipo / Čiaupo jungtis / Krāna īscaurules / Kraaniühendus / Адаптор за кран / Priključak za slavinu / Priključak za slavinu / Πακόρ για βρύση / Conector para grifo / Adattatore per rubinetto / União de torneira / Ajustage de robinet / Kraanverbindstuk



1



15G740 12/96

VERTO

x1 1/2"-3/4" x30



15G740-30 1/6



Złącza

Connector / Kupplung / Соединитель / З'єднувальний елемент / Csatlakozó / Manşon / Spojka / Spájací článok / Spojka / Jungtis / Savienotājs / Ühendused / Μυφα / Klema / Spojka / Σύνδεσμος / Conector / Raccordo / União / Raccord / Sproeier



2



15G720 12/96

VERTO

1/2" x1 3/4"



15G722 12/96



2



15G720-30 1/1



VERTO

1/2" x30 3/4"



15G722-30 1/1

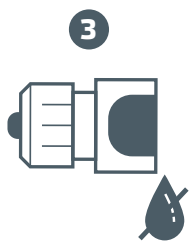

3



15G721 12/96

VERTO

STOP
1/2" x1 3/4"



15G723 12/96

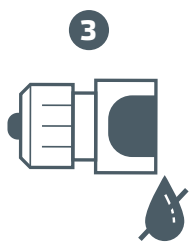

3



15G721-30 1/1

VERTO

STOP
1/2" x30 3/4"



15G723-30 1/1



Rozdzielacz typu Y

3 way hose connector / Y-Schlauchverteiler / Тройник / Сепаратор-трійник / 3-utas csatlakozó / Conector extensie triplu / Y-kus / Rozdeľovač typ Y / Razdelilnik tipa Y / Trišakis greito jungimo laistymo žarnos sujungti, Y tipo / Y tipa sadalītājs / Y-tiüüri jaotur / Тройник за бързи връзки / Y razvodnik / Razdelnik tipa Y / Σύνδεσμος τριών ταχουσυνδέσμων / Derivación tipo Y triple / Raccordo a Y / União em Y / Répartiteur de type Y / 3-weg stuk Y

VERTO



15G744 12/96



x1



15G745 12/96



x1

VERTO

VERTO

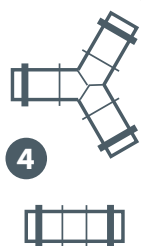

15G744-30 12/96



x30



15G745-30 12/96



Reparator do węza

Hose repair connector / Schlauchverbinder / Универсальная ремонтная муфта / Репаратор до шлангу / Tömlőtoldó javító / Cupla imbinare furtun / Hadicová oprávka / Hadicová spojka / Reparatör za cev / Jungtis žarnai / Remontuzmava dārza šjūtenei / Vooliku parandamise ühendus / Муфта-соединитель за маркуч / Reparatör za crijevo / Reparatör za crevo / Σύνδεσμος για ένωση δύο λάστιχων / Reparatör de manguera / Raccordo riparatore / Reparatör de mangueira / Réparateur de tuyau / Knellkoppeling

VERTO



15G742 12/96



1/2" x1 3/4"



15G743 12/96

VERTO



15G742-30 1/1



1/2" x30 3/4"



15G743-30 1/1



Rozdzielacz

Faucet extender / Verteiler / Разделитель / Розподільювач / Vízelosztó / Distributor / Rozdělovač / Separátor / Kolektor / Kolektorius / Kolektors / Kollektor / Колектор / Kolektora / Колектора / Συλλέκτης / Colector / Estensione / Manifold / Collecteur / Spruitstuk

NEO
TOOLS



15-750 1/10



VERTO



15G760 12/72



15G761 10/40



Wyłącznik czasowy

Timer switch / Wasserschaltuhr / Таймер для полива / Вимикач таймерний / Öntözö időzítő kapcsoló / Programator irigații / Časový spínač / Časový spínač / Časovník / Laistymo laikmatis / Laika slēdzis / Taimeriga lüliti / Таймер за изключване / Vremenski prekidač / Tajmer / Χρονοδιακόπτης ποτίσματος / Temporizador / Interruttore temporizzato / Programador de rega / Minuterie d'arrosage / Tijdschakelaar

VERTO



15G750 1/12



15G751 1/4



Opryskiwacz

Spraying machine / Spritzgerät / Опрыскиватель / Опрыскувач / Permetező / Aparat de stropit / Postřikovač / Postrekovač / Škropilník / Purkštuvos / Smidzinātājs / Piserdi / Пулверизатор / Prskalica / Prskalica / Ψεκαστήρας / Aspensor / Atomizzatore / Máquina regadora / Pulvérisateur / Spuittoestel

NEO
TOOLS

3.6V DC
Li-Ion

2000
mAh

2,41
bar

Ta +40°C
0°C



15-715 1000 ml 1/18

Spryskiwacz

Spraying machine / Spritzgerät / Опрыскиватель / Опрыскувач / Permetező / Aparat de stropit / Postřikovač / Postrekovač / Škropilník / Purkštuvos / Smidzinātājs / Piserdi / Пулверизатор / Prskalica / Prskalica / Ψεκαστήρας / Aspensor / Atomizzatore / Máquina regadora / Pulvérisateur / Spuittoestel

VERTO



15G545 550 ml 1/100
15G546 1000 ml 1/48

Opryskiwacz

Spraying machine / Spritzgerät / Опрыскиватель / Опрыскувач / Permetező / Aparat de stropit / Postřikovač / Postrekovač / Škropilnik / Purkštuvus / Smidzinātājs / Piserdi / Пулверизатор / Prskalica / Prskalica / Ψεκαστήρας / Aspersor / Atomizzatore / Máquina regadora / Pulvérisateur / Spuittoestel

VERTO



MAX
0,25
L/min

max 2,5
bar

MAX
1,6
L/min

max 3
bar



15G501	1 L		1/20
15G502	1,5 L		1/15
15G503	2 L		1/15

15G504	3 L		1/6
15G505	5 L		1/6
15G506	7 L		1/6

VERTO



MAX
1,6
L/min

max 3,5
bar



15G507	15 L		1/1
15G508	20 L		1/1





NARZĘDZIA RĘCZNE

HAND TOOLS

РУЧНИЙ ІНСТРУМЕНТ



NARZĘDZIA RĘCZNE

Narzędzia ręczne

Dzięki regularnemu podcinaniu ogrodu, wygląda on estetycznie, a dodatkowo krzewy i trawa mogą się prawidłowo rozwijać. Akcesoria takie jak rękawiczki to niezbędne wyposażenie ogrodników profesjonalnych jak i entuzjastów ogrodnictwa. Na niepogodę wybierz solidne kalosze, a po skończonej pracy - ciesz się pięknymi efektami z pomocą odpowiedniego oświetlenia.

Oferujemy szeroki asortyment narzędzi ręcznych, odpowiednich do każdego zadania w ogrodzie. Nasza oferta obejmuje m.in.: siekiery, piły, łopaty, sekatory, nożyce, rękawice ochronne oraz inne akcesoria. Narzędzia ręczne charakteryzuje solidność, prostota w obsłudze oraz nowoczesny wygląd. Używając narzędzi ręcznych VERTO i NEO TOOLS sprawisz, że Twój ogród będzie zawsze robił wrażenie.

Zapoznaj się z naszą ofertą!

HAND TOOLS

РУЧНИЙ ІНСТРУМЕНТ

Hand tools

By regularly pruning the garden, it looks aesthetically pleasing, additionally shrubs and grass can develop properly. Accessories such as gloves are essential equipment for professional gardeners as well as gardening enthusiasts. For inclement weather, choose sturdy wellingtons, and when you're done working - enjoy the beautiful results with the help of appropriate lighting.

We offer a wide range of hand tools, suitable for any task in the garden. Our offer includes, among others: axes, saws, shovels, secateurs, shears, protective gloves and other accessories. Hand tools are characterized by robustness, ease of use and modern design. Using VERTO and NEO TOOLS hand tools you will make your garden always impressive.

Take a look at our offer!

Ручний інструмент

Завдяки регулярній стрижці, сад має естетичний вигляд, а кущі і трава можуть правильно розвиватися. Такі аксесуари, як рукавички, є необхідністю як для професійних садівників так і для садівників-любителів. Для непогоди вибирайте міцні галосі, а після роботи - насолоджуйтеся красивими ефектами за допомогою відповідного освітлення.

Ми пропонуємо широкий асортимент ручних інструментів, які підходять для будь-яких робіт у саду. Наша пропозиція включає, між іншим: сокири, пилки, лопати, секатори, ножиці, захисні рукавички та інші аксесуари. Ручні інструменти відрізняються міцністю, зручністю у використанні та сучасним зовнішнім виглядом. Використовуючи ручні інструменти VERTO і NEO TOOLS, ви зробите свій сад завжди вражаючим.

Познайомтеся з нашою пропозицією!



Sektor ogrodowy

Garden pruner / Gartenschere / Секатор садовый / Секатор садовый / Metszőolló / Foarfeca de gradina / Zahradnické nůžky / Nožnice záhradnícke / Vrtne škarje / Sodo sektorius / Dārza grieznes / Oksakäärid / Ножица лозарска / Škare za obrezivanje / Makaze za orezivanje / Φαλίδι κλαδέματος / Tijeras de jardín / Cesóia da giardino / Podadeira para jardim / Sécateur de jardin / Tuintakkschaar



NEO
TOOLS



15-210 12/48



NEO
TOOLS



15-211 12/48



NEO
TOOLS



15-212 12/48



NEO
TOOLS



15-213 12/48



Sektor ogrodowy

Garden pruner / Gartenschere / Секатор садовый / Секатор садовый / Metszőolló / Foarfeca de gradina / Zahradnické nůžky / Nožnice záhradnícke / Vrtne škarje / Sodo sekatorius / Dārza grieznes / Oksakäärid / Ножица лозарска / Škare za obrezivanje / Makaze za orezivanje / Ψαλίδι κλαδέματος / Tijeras de jardín / Cesoia da giardino / Podadeira para jardim / Sécateur de jardin / Tuintakenschaar

NEO
TOOLS



15-204 10/60



MAX
∅
18mm



200
mm

POWER
+30%



NEO
TOOLS



15-202 10/60



MAX
∅
18mm



200
mm

POWER
+30%



NEO
TOOLS



15-203 10/60



MAX
∅
18mm



200
mm

POWER
+30%



NEO
TOOLS



15-200 10/60



MAX
∅
15mm



185
mm

POWER
+30%



NEO
TOOLS



15-201 10/60



MAX
∅
18mm



185
mm

POWER
+30%





Sektor ogrodowy

Garden pruner / Gartenschere / Секатор садовый / Секатор садовый / Metszőolló / Foarfeca de gradina / Zahradnické nůžky / Nožnice záhradnícke / Vrtné škarje / Sodo sektorius / Dārza grieznes / Oksakäärid / Ножица лозарска / Škare za obrezivanje / Makaze za orezivanje / Φαλιδι κλαδέματος / Tijeras de jardín / Cesola da giardino / Podadeira para jardim / Sécateur de jardin / Tuintakenschaar

NEO
TOOLS



15-208  10/60



NEO
TOOLS



15-207  10/100

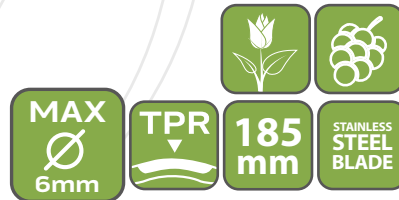

VERTO



15G206  12/72



VERTO



15G207  12/72



VERTO



15G200  12/72



VERTO



15G201  12/72



Sekator ogrodowy

Garden pruner / Gartenschere / Секатор садовый / Секатор садовый / Metszőolló / Foarfeca de gradina / Zahradnické nůžky / Nožnice záhradnícke / Vrtné škarje / Sodo sekatorius / Dārza grieznes / Oksakäärid / Ножица лозарска / Škare za obrezivanje / Makaze za orezivanje / Ψαλίδι κλαδέματος / Tijeras de jardín / Cesoia da giardino / Podadeira para jardim / Sécateur de jardin / Tuintakenschaar

VERTO

15G202  12/72



BY-PASS
BLADES



MAX
∅
12mm



210
mm

POWER
+30%



VERTO

15G203  12/72



ANVIL
BLADES



MAX
∅
12mm



210
mm

POWER
+30%



VERTO

15G204  10/60



BY-PASS
BLADES

MAX
∅
15mm

220
mm

POWER
+30%

AL



VERTO

15G205  12/72



ANVIL
BLADES

MAX
∅
20mm



190
mm

POWER
+30%



VERTO

15G208  6/72



BY-PASS
BLADES

MAX
∅
10mm

200
mm





Sektor do galeži

Lopping shears / Astschere / Сучкорез / Сучкоріз / Ágvágó olló / Foarfeca de gradina / Zahradnické nůžky na větve / Nožnice na konáre / Škarje za obrezovanje vej / Sekatorius šakoms / Grieznes zariem / Kárpimiskäärid / Ножица за клони / Škare za grane / Makaze za grane / Φαλίδα κλαδέματος / Tijeras de podar / Cesola per rami / Poadeira de ramos / Sécateur à branches / Takkenschaar



NEO
TOOLS



15-251 1/12



MAX \varnothing 40mm

POWER +60%

BIMATERIAL GRIPS

AL



NEO
TOOLS



15-252 1/12



MAX \varnothing 40mm

POWER +40%

BIMATERIAL GRIPS

AL



NEO
TOOLS

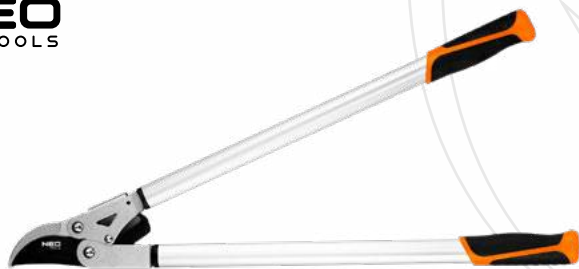

15-250 1/12



MAX \varnothing 45mm

POWER +30%

BIMATERIAL GRIPS

AL



VERTO



15G256 1/12



MAX \varnothing 40mm

POWER +40%

BIMATERIAL GRIPS

AL



Sektor do gałęzi

Lopping shears / Astschere / Сучкорез / Сучкоріз / Ágvágó olló / Foarfeca de gradina / Zahradnické nůžky na větve / Nožnice na konáre / Škarje za obrezovanje vej / Sekatorius šakoms / Grieznes zariem / Kärpimiskäärid / Ножица за клони / Škare za grane / Makaze za grane / Ψαλίδα κλαδέματος / Tijeras de podar / Cesoia per rami / Poaddeira de ramos / Sécateur à branches / Takkenschaar

VERTO



15G257 1/12



ANVIL
BLADES

MAX
Ø
40mm

POWER
+60%

BIMATERIAL
GRIPS

AL



VERTO



15G251 6/12



ANVIL
BLADES

MAX
Ø
35mm

POWER
+60%

BIMATERIAL
GRIPS

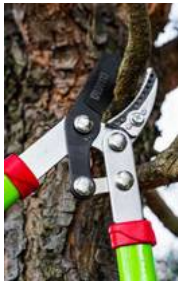

VERTO



15G254 6/12



BY-PASS
BLADES

MAX
Ø
30mm

POWER
+20%

BIMATERIAL
GRIPS



VERTO

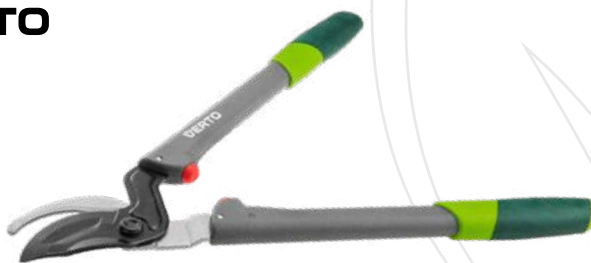

15G255 1/12



BY-PASS
BLADES

MAX
Ø
30mm

FIBREGLASS
HANDLE

BIMATERIAL
GRIPS



VERTO



15G250 6/12



BY-PASS
BLADES

MAX
Ø
30mm

BIMATERIAL
GRIPS



Sekator do galęzi

Lopping shears / Astschere / Сучкорез / Сучкоріз / Ágvágó olló / Foarfeca de gradina / Zahradnické nůžky na větvě / Nožnice na konáre / Škarje za obrezovanje vej / Sekatorius šakoms / Grieznes zariem / Káipimiskäärid / Ножица за клоии / Škare za grane / Makaze za grane / Ψαλίδα κλαδέματος / Tijeras de podar / Cesóia per rami / Poadeira de ramos / Sécateur à branches / Takkenschaar

NEO
TOOLS

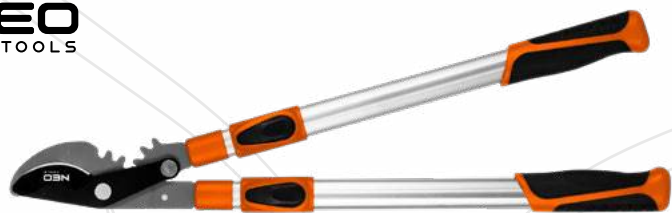

BY-PASS
BLADES

TELESCOPIC
665 - 965
mm

MAX

∅
42mm

POWER
+40%

BIMATERIAL
GRIPS

AL

15-253 1/12



NEO
TOOLS

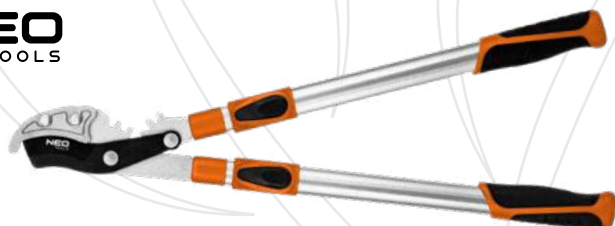

ANVIL
BLADES

TELESCOPIC
665 - 965
mm

MAX

∅
42mm

POWER
+60%

BIMATERIAL
GRIPS

AL

15-254 1/12



VERTO



BY-PASS
BLADES

TELESCOPIC
670 - 970
mm

MAX

∅
45mm

POWER
+40%

BIMATERIAL
GRIPS

AL

15G258 1/12



VERTO



ANVIL
BLADES

TELESCOPIC
670 - 970
mm

MAX

∅
45mm

POWER
+40%

BIMATERIAL
GRIPS

AL

15G259 1/12



VERTO



BY-PASS
BLADES

TELESCOPIC
700 - 1000
mm

MAX

∅
35mm

POWER
+20%

BIMATERIAL
GRIPS

AL

15G253 1/12



Sektor z piłą

Saw pruner / Baumschere mit säge / Секатор с пилой / Секатор з пилою / Ágvágó fűrészel / Foarfecă cu piłą / Zahradní nůžky s pilkou / Nožnice s pilou / Škarje z žago / Sekatorius su pjūkleliu / Dārza grieznes ar zāģi / Lõikur koos saega / Градинарски ножици с трион / Vrtne škare s pilom / Baštenske makaze sa pilom / Ψαλίδι με πριόνι / Tijeras podaderas con sierra / Svettatöilo a pertica con segaccio tagliarami / Podadeira de fita / Séctateur à chenilles / Snoeischaar

VERTO

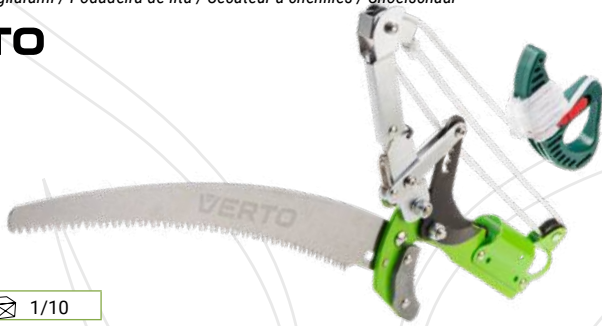

15G260  1/10

WITH
A GEAR

MAX
30mm

RATCHET



Trzonek teleskopowy

Telescopic handle / Teleskopstiel / Штанга телескопическая / Штанга телескопична / Teleszkópos nyél / Manivelă telescopică / Teleskopická násada / Rukovň teleskopická / Teleskopski ročaj / Teleskopinē rankena / Teleskopisks rokturis / Teleskoopkäepide / Телескопична дръжка / Teleskopska drška / Teleskopska drska / Τηλεσκοπικό κονταροπριόνιο / Mango telescópico / Zoccolo telescopico / Cabo telescópico / Manche télescopique / Telescopisch handvat

VERTO



15G261  1/10

TELESCOPIC
1280 - 2400
mm

FOR
15G260

Nożyce do żywopłotu

Hedge shears / Heckenschere / Ножицы для живой изгороди / Ножици до живоплоту / Sövényvágó olló / Foarfece grădină / Nůžky na živý plot / Nožnice na živý plot / Škarje za živo mejo / Žirklés gyvatvorei / Grieznes krūmiem / Hekikäärid / Ножица за храсти / Škare za živu ogradu / Makaze za živu ogradu / Ψαλίδι για φράκτη από θάμνους / Cortasetos eléctrico / Forbici per siepe / Tesoura p. vedação / Cisaille à haie /

VERTO



15G313  1/12

PTFE

POWER
+30%

BIMATERIAL
GRIPS

FIBREGLASS
HANDLE



VERTO



15G312  6/12

PTFE

WAVY
BLADES

TELESCOPIC
670 - 880
mm



VERTO



15G311  6/12

PTFE

WAVY
BLADES

BIMATERIAL
GRIPS



VERTO



15G310  6/12

BIMATERIAL
GRIPS



Nożyce do trawy

Grass shears / Grasschere / Ножицы газонные / Ножици газонні / Fűszegélyvágó olló / Foarfece gazon / Nůžky na trávnik / Nožnice na trávu / Škarje za travo / Žirkles žolei / Grieznes zālājam / Rohukäärid / Ножица за трева / Škare za travu / Makaze za travu / Ψαλίδι για γρασίδι / Forbici per erbe / Tesoura para relva / Cisaille à gazon / Grasscharen

VERTO



15G302  12/48



VERTO



15G301  12/60



VERTO



15G300  10/60

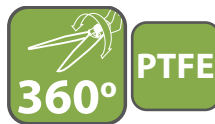

Nożyczki

Scissors / Schere / Ножицы / Ножици / Olló / Foarfece / Nůžky / Nožnice / Škarje / Žirkles / Šķēres / Tijeras / Ножици / Škare / Makaze / Ψαλίδι / Käärid / Forbici

NEO
TOOLS



15-215  12/72



NEO
TOOLS



64-001  12/72





Piła ogrodowa

Saw / Gartensäge / Пила садова / Пилка садова / Ágvágófűrész / Ferestrău / Zahradní pilka / Pílka záhradkárska / Žaga / Pjūklas / Zāģis / Saag / Трион / Pila / Testera / Αλυσοπίρινο / Segá per frutteto / Serra agrícola / Scie de jardin / Boomzaag

NEO
TOOLS



42-101 6/24



7TPI 13"

3D

65 MN

FITTED COVER

BLADE LOCK



NEO
TOOLS



42-102 6/24



6TPI 14"

3D

65 MN

FITTED COVER

BLADE LOCK



Piła ogrodowa

Saw / Gartensäge / Пила садовая / Пилка садова / Ágvágófűrész / Ferestrău / Zahradní pilka / Pílka záhradkárska / Žaga / Pjüklas / Zägis / Saag / Трион / Pila / Testera / Αλυσοπίριο / Segla per frutteto / Serra agrícola / Scie de jardin / Boomzaag

NEO
TOOLS



42-100 6/24

9TPI 6"



65 MN

FOLDABLE
BLADE

BLADE
LOCK



NEO
TOOLS



63-120 12/72

7TPI 8"



SK4

FOLDABLE
BLADE

BLADE
LOCK



VERTO



15G100 1/20

7TPI 7"



65 MN

FOLDABLE
BLADE

BLADE
LOCK

HAND
PROTECTION



VERTO



15G101 1/20

6TPI 14"



65 MN

FITTED
COVER



Piła płatnica

Hand saw / Fuchsschwanzsäge / Пила-ножовка / Ножівка / Kézifűrész / Ferestrău manual / Pilka ocaska / Pílka ručná / Ročna žaga / Pjūklas medžiui / Zāģis kokam / Käsisaag / Трион / Pila ručna / Testera rucna / Σαγιάτρα / Serrucho de carpintero / Segá a mano / Serra / Scie égoïne / Handzaag

NEO
TOOLS

EXTREME ■■■■



41-111	400 mm	☒	6/24
41-116	450 mm	☒	6/24

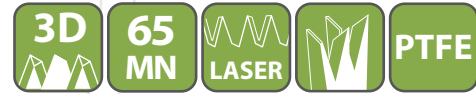

NEO
TOOLS

EXTREME ■■■■



41-131	400 mm	☒	6/24
41-136	450 mm	☒	6/24
41-141	500 mm	☒	6/24

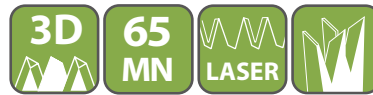

NEO
TOOLS

EXTREME ■■■■



41-161	400 mm	☒	6/24
41-166	450 mm	☒	6/24

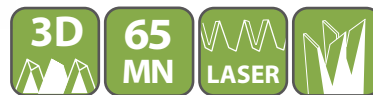

VERTO



15G102	450 mm	☒	6/24
--------	--------	---	------



Piła ręczna łańcuchowa

Piła ręczna łańcuchowa / Hand chain saw / Ручная цепная пила / Ручна ланцюгова пила / Kézi lánccűrész / Ferestrău manual cu lanț / Ruční řetězová píla / Ručná reťazová píla / Ročna verižna žaga / Rankinis grandininis pjūklas / Rokas ķēdes zāģis / Kāsi kettsaag / Ръчен верижен трион / Ručna lančana píla / Ручна моторна тестера / Αλυσοπίοιο χειρός / Motosega a mano / Motosierra manual / Serra manual / Scie à chaîne à main / Hand kettingzaag

NEO
TOOLS



63-158	530 mm	☒	1/30
--------	--------	---	------



Maczeta

Machete / Machete / Мачете / Мачете / Kerti bozótvágó / Machete / Mačeta / Mačeta / Mačeta / Machete / Mačete / Machete / Мачете / Mačeta / Мачета / Μεγάλη / μαχαίρα / Machete / Machete / Machete / Machete / Machete

NEO
TOOLS



10"

STAINLESS
STEEL

BIMATERIAL
HANDLE

63-117 400 mm  6/24

Maczeta ogrodowa

Garden machete / Gartenmachete / Мачете для садовых работ / Мачете садовый / Kerti bozótvágó / Macetă de grădină / Zahradní mačeta / Záhradná mačeta / Vrtna mačeta / Mačeté sodui / Dārza mačete / Aiamatšeete / Градинско мачете / Mačeta za krčenje / Mačeta za rastinje / Ματσέτα κήπου / Machete de jardinería / Machete da giardino / Machete de jardim / Manchette de jardin / Kapmes /

VERTO



19"

WOODEN
HANDLE

15G190  1/48

VERTO



18"

WOODEN
HANDLE

15G191  1/48

Saperka skládana

Trenching shovel / Pionierspaten / Саперная лопата / Лопатка саперна / Ásó tábori / Lopatä mică / Rýč / Malá lopatka / Lopata / Kastuvélis / Sapiera lāpsta / Sapöörilabidas / Малка пехотна лопата / Lopatica / Pionirski ašov / Φτυάρι λαμού / Pala de trinchera / Pala ripiegabile / Pá pequena / Pelle à manche court

NEO
TOOLS



FOLDABLE

5 in 1

WRENCH
10mm

SHOVEL

SAW

PICKAXE

BOTTLE
OPENER

63-121  1/20

VERTO



FOLDABLE

15G075  1/12

Siekiera

Axe / Axt / Топор / Сокира / Balta / Topor / Sekera / Sekera / Sekira / Kirvis / Cirvis / Kirves / Брџва / Sjekira / Sekira / Τσικοῦρι / Hacha / Ascia / Machado / Hache / Bijl



NEO
TOOLS



DIN
7294

FIBREGLASS
HANDLE



27-033 2200 g 2/4

NEO
TOOLS



DIN
5131

FIBREGLASS
HANDLE

27-030	400 g		12/24
27-031	700 g		6/12
27-032	850 g		6/12

VERTO



FIBREGLASS
HANDLE



05G104 1000 g 4/8

VERTO



FIBREGLASS
HANDLE

05G102	410 g		12/24
05G100	410 g		12/24
05G101	540 g		6/12
05G103	800 g		4/8

Siekiera

Axe / Axt / Топор / Сокира / Balta / Topor / Sekera / Sekera / Sekira / Kirvis / Cirvis / Kirves / Брџва / Sjekira / Sekira / Τσικοῦρι / Hacha / Ascia / Machado / Hache / Bijl

NEO
TOOLS

EXTREME



27-120	600 g	DIN 5131	6/24
27-121	800 g	DIN 5131	6/24
27-123	1250 g	DIN 7294	1/12
27-124	1500 g	DIN 7294	1/12



DIN 5131

DIN 7294

FIBREGLASS HANDLE

BIMATERIAL

NEO
TOOLS



27-050	2500 g	1/4
--------	--------	-----



FIBREGLASS HANDLE

BIMATERIAL

VERTO



05G201	600 g	4/16
--------	-------	------

DIN 5131

FIBREGLASS HANDLE

VERTO



05G202	1500 g	1/4
--------	--------	-----

DIN 7294

FIBREGLASS HANDLE

VERTO



05G203	2700 g	1/2
--------	--------	-----

DIN 7294

FIBREGLASS HANDLE

Siekiera

Axe / Axt / Топор / Сокира / Balta / Topor / Sekera / Sekera / Sekira / Kirvis / Cirvis / Kirves / Брџва / Sjekira / Sekira / Τσεκούρι / Hacha / Ascia / Machado / Hache / Bijl

TOPEX

05A220	600 g	DIN 5131	☒	6/24
05A221	800 g	DIN 5131	☒	6/18
05A222	1000 g	DIN 5131	☒	1/6
05A223	1250 g	DIN 7294	☒	1/6



DIN
5131

DIN
7294

FIBREGLASS
HANDLE

TOP TOOLS

05A206	600 g	☒	1/24
05A208	800 g	☒	1/24
05A210	1000 g	☒	1/24
05A212	1250 g	☒	1/12



FIBREGLASS
HANDLE

NEO TOOLS

27-006	600 g	☒	6/24
27-008	800 g	☒	6/12
27-010	1000 g	☒	6/12



DIN
5131



100%
Wood
FSC® C146673



NEO TOOLS

27-012	2000 g	☒	4/8
--------	--------	---	-----



DIN
7294



100%
Wood
FSC® C146673



NEO TOOLS

27-019	2000 g	☒	2/4
--------	--------	---	-----



100%
Wood
FSC® C146673



TOPEX

05A148	2000 g	☒	1/6
--------	--------	---	-----



WOODEN
HANDLE

Siekiera

Axe / Axt / Топор / Сокира / Balta / Topor / Sekera / Sekera / Sekira / Kirvis / Cirvis / Kirves / Брaдвa / Sjekira / Sekira / Τσεκούρι / Hacha / Ascia / Machado / Hache / Bijl

TOPEX

05A136	600 g	DIN 5131	☒	1/24
05A138	800 g	DIN 5131	☒	6/24
05A140	1000 g	DIN 5131	☒	1/12
05A142	1250 g	DIN 7294	☒	6/12
05A146	1600 g	DIN 7294	☒	1/1



DIN
5131

DIN
7294

WOODEN
HANDLE

TOP TOOLS

05A306	600 g	☒	1/24
05A308	800 g	☒	1/11
05A310	1000 g	☒	6/12
05A312	1250 g	☒	1/11



WOODEN
HANDLE

Trzonek

Shank / Stiel / Рукoяткa / Хвостовик / Baltanyél / Mânier / Násada / Trň / Ročaj / Kotas / Spals / Vars / Цокъл / Držak / Drška, držalo / Χειρολαβή / Vástago / Manico per ascia / Cabo / Manche / Handvat

TOPEX

05A436	360 mm	☒	1/50
05A450	500 mm	☒	1/25
05A460	600 mm	☒	1/25
05A470	700 mm	☒	1/25



WOODEN
HANDLE

Klin

Wedge / Keil / Клиn / Клиn / Ёк / Pană / Klín / Klin / Klin / Pleištas / Қіліс / Kiil / Клиn / Klin / Klin / Σφήνα / Сућа / Cuneo / Cunha / Cale / Wig

NEO TOOLS

27-201	5,5"	☒	5/100
27-202	8"	☒	20/40
27-203	10"	☒	20/40



NEO TOOLS

27-211	800 g	☒	1/20
--------	-------	---	------



27-212	800 g	☒	1/20
--------	-------	---	------



27-213	550 g	☒	1/20
--------	-------	---	------



AL

Oselka

Sharpening stone / Schleifstein / Точильный камень / Брусок / Fenőkő / Piatra pentru ascutit / Brousek / Oslička obdžníková / Kamen za brušenje / Akmuo galandimui / Galoda / Luisk / Брус / Kamen za oštrenje / Kamen za oštrenje / Λίθος τροχίσματος / Taco de lijar / Pietra per affilare / Pedra de amolar / Pierre à aiguiser / Slijpsteen

NEO TOOLS

56-007	☒	25/50
--------	---	-------

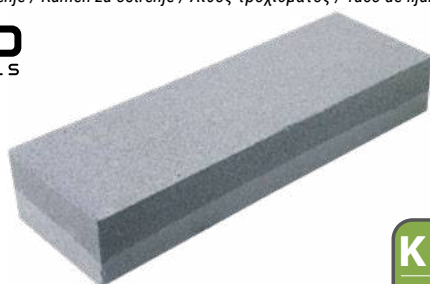

K 100
K 200

56-008	☒	1/100
--------	---	-------

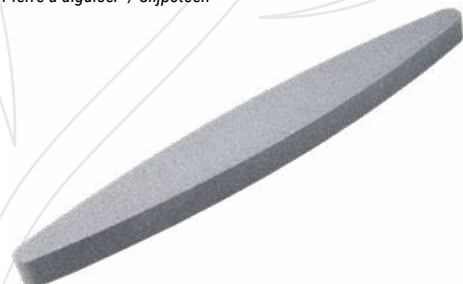

K 180



Szpadel

Spade / Spaten / Заступ / Лопата багнетова / Ásó nyelezve / Lopăţică / Rýč / Rýř ľichobeţnikový / Lopata / Kastuvas / Lăpsta / Labidas / Лопата права / Lopata / Lopata / Φτυάρι / Pala / Pala / Pá / Louchet / Spade



VERTO



15G001 1/6



15G002 1/6

VERTO



15G003 1/6

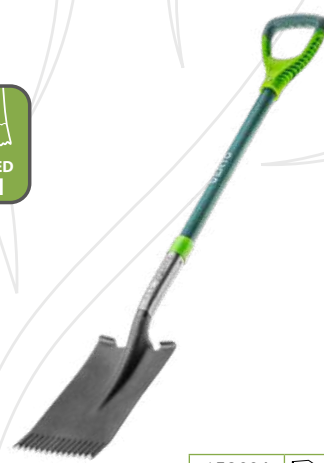

15G004 1/6

Szpadel

Spade / Spaten / Заступ / Лопата багнетова / Ásó nyelezve / Lopățică / Rýč / Rýř lichožezníkuvý / Lopata / Kastuvas / Lápsta / Labidas / Лопата права / Lopata / Lopata / Φτυάρι / Pala / Pala / Pá / Louchet / Spade

NEO
TOOLS



DURABLE

HARDENED

SOFT

95-008-1  0/1



95-007-1  0/1



NEO
TOOLS



DURABLE

HARDENED

SOFT

95-008  1/6



95-007  1/6



VERTO



DURABLE

HARDENED

15G010-1  0/1



15G011-1  0/1



VERTO



DURABLE

HARDENED

15G010  1/6



15G011  1/6



Szpadel

Spade / Spaten / Заступ / Лопата багнетова / Ásó nyelezve / Lopățică / Rýč / Rýř lichožeňníkový / Lopata / Kastuvas / Lāpsta / Labidas / Лопата права / Lopata / Lopata / Φτυάρι / Pala / Pala / Pá / Louchet / Spade

VERTO



15G026 0/1



15G027 0/1



VERTO



15G014 1/6



15G017 1/5



Szpadel

Spade / Spaten / Заступ / Лопата багнетова / Ásó nyelezve / Lopățică / Rýč / Rýř lichožeňníkový / Lopata / Kastuvas / Lāpsta / Labidas / Лопата права / Lopata / Lopata / Φτυάρι / Pala / Pala / Pá / Louchet / Spade

NEO TOOLS



95-004 0/1

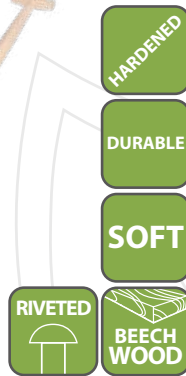

Lopata

Shovel / Schaufel / Лопата / Лопата совкова / Lapát nyelezve / Lopată / Lopata / Lopata ocelová / Lopata / Kastuvas / Lāpsta / Kühvel / Лопата крива / Lopata / Lopata / Φτυάρι / Pala / Badile / Pá / Pelle / Schep

NEO TOOLS

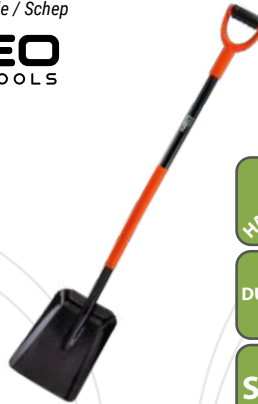

95-011 1/6



Lopata

Shovel / Schaufel / Лопата / Лопата совкова / Lapát nyelezve / Lopată / Lopata / Lopata ocelová / Lopata / Kastuvas / Lāpsta / Kühvel / Лопата крива / Lopata / Lopata / Φτυάρι / Pala / Badile / Pá / Pelle / Schep

VERTO



15G012-1 0/1



15G012 1/6



Lopata

Shovel / Schaufel / Лопата / Лопата совкова / Lapát nyelezve / Lopatä / Lopata / Lopata ocel'ová / Lopata / Kastuvus / Lápsta / Kühvel / Лопата крива / Lopata / Lopata / Φτυδρι / Pala / Badile / Pá / Pelle / Schep

VERTO



HARDENED

BEECH WOOD

15G018  0/1

15G019  0/1

15G020  0/1

15G021  0/1

Motyka

Hoe / Handhacke / Мотыжка / Сапка / Кара / Särpälīgä / Motyka / Motyčka / Motika / Purentuvus / Kaplis / Kõblas / Мотика / Motika / Motičica / Σκαλιστήρι / Azada / Zappetta / Enxada / Brosse à joints

VERTO



ERGONOMIC

SOFT

BEECH WOOD

15G030 16 cm  0/1

15G039 14 cm  0/1

15G081  0/1

VERTO

Grabie

Rake / Rechen / Грабли / Грабли / Gereblye / Greblä / Hrábě / Hrable / Grablje / Greblys / Gräbeklis / Reha / Гребло / Grablje / Grablje / Τσουγκράνα / Rastrillo / Rastrello / Ancinho / Râteaux / Hark



Grabie

Rake / Rechen / Грабли / Грабли / Gereblye / Greblä / Hrábě / Hrable / Grablje / Greblys / Gräbeklis / Reha / Гребло / Grablje / Grablje / Τσουγκράνα / Rastrillo / Rastrello / Ancinho / Râteaux / Hark

VERTO





BEECH WOOD

WOODEN HANDLE

15G056 12 teeth  0/1

15G057 14 teeth  0/1

15G050 16 teeth  0/1

15G058 18 teeth  0/1

15G051  0/1

Widly

Fork / Gabel / Вилы / Вила / Villa / Furcã / Vidle / Vidly záhradnícke / Vile / Šakės / Dakšas / Hark / Вила / Vile sa štilom / Vile / Δίκρανο / Forca / Forcado / Fourche / boormachine zonder slag

VERTO



4

TEETH

DURABLE

WOODEN
HANDLE

15G040  1/6

15G041  1/6

Trzonek

Shank / Stiel / Рукоятка / Хвостовик / Szerszámnyél / Mánier / Násada / Trň / Ročaj / Kotas / Spals / Vars / Цокъл / Držak / Drška, držalo / Χειρολαβή / Vástago / Manico per ascia / Cabo / Manche / Handvat

VERTO



15G061  0/1



15G062  0/1



15G063  0/1

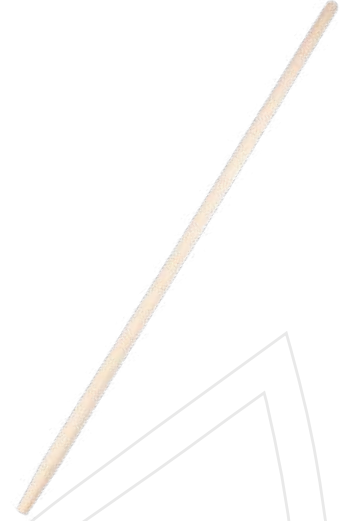

Swider do gleby

Soil auger / Erdbohrer / Почвенного шнека / Грунтового шнека / Talajfúró / Burghiului de sol / Půdní šnek / Pôdny vrták / Sveder za zemljo / Dirvos sraigtas / Augšnes urbis / Mullatigu / Шнек за почва / Svrdo za zemlju / Свеж за тло / Τριπάνι εδάφους / Barrena de suelo / Coclea del terreno / Trado de solo / Tarière à terre / Grondboor

VERTO



DURABLE

15G071 110 mm  0/1



15G072 250 mm  0/1

Wyrwacz do chwastów

Weed whacker / Unkrautstecher / Рыхлитель сорняков / Gyomírtó készülék / Maşină de curăţat buruieni / Šlehač na plevel / Šľahač buriny / Strojek za odstranjevanje plevela / Piktžolių naikiklis / Nezāju plāvēji / Резачка за плевели / Хортокопτικό / Desbrozadora / Diserbante / Caçador de ervas daninhas / Faucheuse de mauvaises herbes / Onkruidverdelger

VERTO



15G045 1/20

CARBON
STEEL



Wyrwacz do chwastów

Weed whacker / Unkrautstecher / Рыхлитель сорняков / Gyomkiszedő / Maşină de curăţat buruieni / Šlehač na plevel / Šľahač buriny / Strojek za odstranjevanje plevela / Piktžolių naikiklis / Nezāju plāvēji / Резачка за плевели / Хортокопτικό / Desbrozadora / Diserbante / Caçador de ervas daninhas / Faucheuse de mauvaises herbes / Onkruidverdelger

VERTO



15G450 1/12

AL

Chwytek do śmieci

Trash grab / Müllgreifer / Захват мусора / Сміттезбірник / Hulladékcsipesz / Captură de gunoi / Popelnice / Uchopenie odpadu / Zgrabite smeti / Šiukšlių griebimas / Atkritumu sagrābšana / Prūgipiūdiņa / Вземане на боклук / Нватач смеца / Цхвитак до смеци / Αρτάξτε τα σκουπίδια / Agarre de basura / Afferrare la spazzatura / Apanhar o lixo / Pince à ordures / Prullenbak

VERTO



AL



15G459 0/24



Aerator ręczny, wertykulator walcowy do trawy

Hand aerator, lawn roller velocirculator / Handbelüfter, Rasenwalze Velocirculator / Ручной аэратор, газонный каток-велоциркулятор / Ручний аератор, газонний велоциркулятор / Kézi levegőztető, gyepszellőztető henger / Aerator de mână, role de gazon velocirculator / Ruční provzdušňovač, travní válec velocirkulátor / Ručný prevzdušňovač, valec na trávnik / Ročni prežračevalnik, valjček za trato velocirkulator / Rankinis aeratorius, vejos volas velocirkuliacinis / Rokas aerators, zāliena veltnis velocirkulators / Käsiaerator / Ръчен аератор, валяк за тревни площи / Ručni aerator, velo cirkulacija s valjkom za travnjak / Ручни аератор, велоциркулятор са вальком за травњак / Χειροκίνητος εζαερωτήρας, ρολό γκαζόν, κυκλοφορητής / Aireador manual, rodillo de césped velocirculador / Arieggiatore manuale, rullo velocipede / Arejador manual, rolo de relva velocirculador / Aérateur à main, rouleau à gazon vélocirculateur / Handbeluchter, gazonroller velocirculator

VERTO

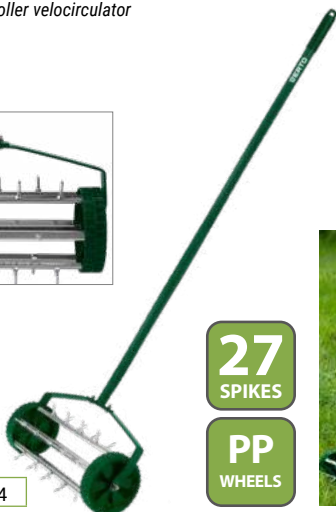

27
SPIKES

PP
WHEELS

15G539 4/4



Aerator sandalowy

Sandal aerator / Sandelbelüfter / Сандаловый аэратор / Szandál levegőztető / Aerator pentru sandale / Provzdušňovač písku / Prevzdušňovač sandálov / Peskovni prežračevalnik / Smélio aeratorius / Smišu aerators / Аератор за пясък / Αεριστήρας σανδαλιού / Aireador de arena / Aeratore per sandali / Arejador de sandálias / Aérateur de sable / Sandaal beluchter

VERTO



x13



15G540 1/20



Kosiarka ręczna

Hand lawn mower / Hand-rasenmäher / Ручная газонокосилка / Ручна газонокосарка / Kézi fűnyíró / Mašina de tuns iarba / Ruční sekačka / Ručná kosačka / Ročna kosilnica / Rankinè vejarjovè / Rokas zāles pļāvējs / Rokas zāles pļāvējs / Ръчна косачка / Ručna kosilica / Ручна косилица / Χορτοκοπτική μηχανή χεριών / Cortacésped manual / Tagliarba a mano / Cortador de grama manual / Tondeuse à gazon à main / Hand grasmaaier /

VERTO

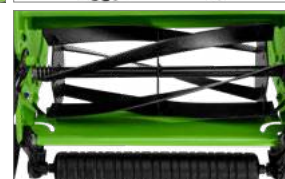

15G350 1/1

16L

LIGHT WEIGHT

CUTTING WIDTH
300 mm

CUTTING HEIGHT
12-45 mm

Lopatka

Garden trowel / Kleiner spaten / Лопатка / Лопатка / Kislapát / Lopata pentru zapada / Lopata na sniž / Lopata na snež / Lopata za snež / Kastuvas sniegui / Lāpsta sniegam / Lumelabidas / Лопатка / Lopatica / Lopata za snež / Φτυάρι για το χιόνι / Hombro / Spalla / Ombro / Lépaule / Schepje

VERTO



BIMATERIAL GRIPS



BIMATERIAL GRIPS



15G405 340 mm 6/36

15G406 350 mm 6/36

Grabki

Small rake / Kleiner rechen / Грабелки / Грабелки / Gereblye mini / Greblā / Hrable / Hrablečky / Grabljice / Grēbliukas / Grābeklis / Reha / Градинарско гребло / Grablje / Grabljice / Τσουγκράνα / Rastrillo / Rastrellino / Forquilhas / Petit râteau

VERTO



BIMATERIAL GRIPS

15G407 3100 mm 6/36

Pazurki

Hand cultivator / Handkultivator / Тяпка посадочная / Розпушувач / Talajlazító / Cultivator / Купрїч / Kultivátor Szubový / Kultivator / Purentuvus / Kultivātors / Kultivaator / Култиватор градински / Kultivator / Kultivator / Φρεζόροτρο / Rastrillo pequeño / Coltivatore / Garras / Griffes / Kweker

VERTO



BIMATERIAL GRIPS

15G408 365 mm 6/36



Motyczka

Small hoe / Handhacke / Тяпка / Сапка / Ūltetó kapa / Grapā / Motyčka / Motyčka / Motika / Kauprtukas / Kaplis / Kōblas / Мотичка градинска / Motika / Motika / Τσάπα / Zappa / Enxada / Houlette / Schöffel

VERTO



BIMATERIAL GRIPS

15G410 340 mm 6/36



BIMATERIAL GRIPS

15G409 340 mm 6/36



Zestaw narzędzi ogrodowych

Garden tool set / Gartenwerkzeugset / Комплект садовых инструментов / Комплект городского инструмента / Kerti szerszámkészlet / Set unelte de grădinărit / Sada zahradnického náradí / Súprava záhradného náradia / Komplet vrtnih orodij / Sodo įrankių rinkinys / Dārza instrumentu komplekts / Aiatööriistade komplekt / Комплект градинарски инструменти / Set vrtnog alata / Pribor alata za baštu / Σετ εργαλείων κήπου / Juego de herramientas de jardín / Completo di attrezzi per giardinaggio / Kit de ferramentas / Jeu d'outils / Set van doppen

VERTO



15G419 1/12



Lopatka

Garden trowel / Kleiner spaten / Лопатка / Лопатка / Kislapát / Lopata pentru zapada / Lopata na sniž / Lopata na sneh / Lopata za sneg / Kastuvas sniegui / Lāpsta sniegam / Lumelabidas / Лопатка / Lopatica / Lopata za sneg / Φτυάρι για το χιόνι / Hombro / Spalla / Ombro / Lépaule / Schepje

VERTO



15G414 285 mm 1/48



15G413 285 mm 1/48



Widelki

Forks / Gabeln / Вилки / Виделки / Villa, mini / Furculițe / Vidlice / Plastové / Plastične / Plastikēns / Plastmasas / Kahvlid / Вилници / Vilice / Форк / Προύνια / Forquillas / Forchette / Garfos / Fourchettes / Vorken

VERTO



15G412 265 mm 1/48



Grabki

Small rake / Kleiner rechen / Грабельки / Грабельки / Gereblye mini / Greblā / Hrale / Hrabličky / Grabljice / Grēbliukas / Grābeklis / Reha / Градинарско гребло / Grablje / Grabljice / Τσουγκράνα / Rastrillo / Rastrellino / Forquilhas / Petit râteau



15G411 310 mm 1/48



Motyczka

Small hoe / Handhacke / Тяпка / Сапка / Ūtetož kara / Grapā / Motyčka / Motyčka / Motika / Кауртукас / Карлис / Kōblas / Мотичка градинска / Motika / Motika / Τσάρα / Zappa / Enxada / Houlette / Schoffel

Pazaruki

Hand cultivator / Handkultivator / Тяпка посадочная / Розпушувач / Talajlazító / Cultivator / Купріч / Kultivátor / Zzubový / Kultivator / Purentuvus / Kultivātors / Kultivaator / Култиватор градински / Kultivator / Kultivator / Φρεζόροτρο / Rastrillo pequeño / Coltivatore / Garras / Griffes / Kweker



15G417 320 mm 1/48



15G415 260 mm 1/48



15G416 290 mm 1/48

NEO
TOOLS

EASY ASSEMBLY **METAL STRUCTURE** **FOLDABLE**
 0,3 mm



PVC FOIL
4 SHELVES



PE FOIL
8 SHELVES



15-902 143x73x195 cm 0/1

15-911 143x143x195 cm 0/1

NEO
TOOLS

EASY ASSEMBLY **METAL STRUCTURE** **PE FOIL** **FOLDABLE**
 0,3 mm



4 SHELVES



3 WINDOWS

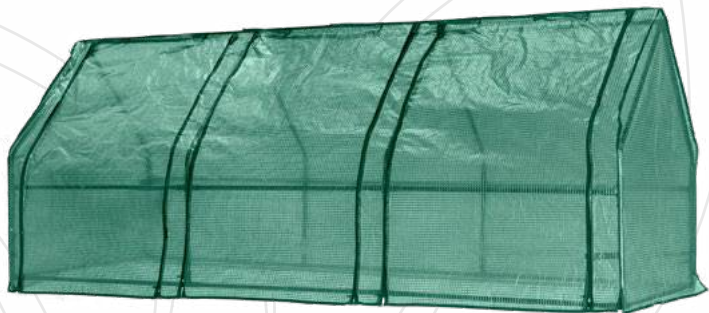

15-903 69x49x160 cm 0/1

15-912 240x90x90 cm 0/1



Szklarnia

Greenhouse / Gewächshaus / Парник / Növényház / Serä / Skleník / Skleník / Rastlinjak / Šiltnamis / Siltumnīca / Оранжерия / Θερμοκήπιο / Invernadero / Serra / Estufa / Serre / Serre

NEO
TOOLS

EASY
ASSEMBLY

METAL
STRUCTURE
0,3 mm

PVC
FOIL



FOLDABLE



2
SHELVES

15-900 69x49x95 cm 0/1



4
SHELVES

15-901 69x49x160 cm 0/1



2
SHELVES

15-910 69x49x95 cm 0/1

Rozsadniki torfowe

Peat seedpods / Torftöpfe / Торфяные горшочки / Торф'яні горщики / Tőzegedények / Vase de turbă / Rašelinové hrnce / Rašelinové hrnce / Šotni lončiči / Durpių puodai / Kūdras podi / Turbapotid / Торфени саксии / Тресетне посуде / Глэдэтрэс тўрфэс / Macetas de turba / Vasi di torba / Vasos de turfa / Pots de tourbe / Turf potten

VERTO



x 60

15G463 8x8x7.8 cm 1/12



x 80

15G464 8x8x7.8 cm 1/24



VERTO



x 10

15G465 16x12x4.5 cm 1/24

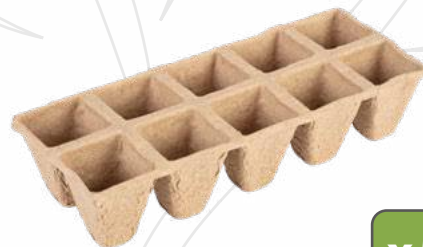

x 5

15G466 16x12x4.5 cm 1/24



Zestaw do sadzenia

Planting kit / Pflanzset / Набор для посадки / Ültetőkészlet / Trusa de plantare / Sada pro výsadbu / Set za sajenje / Sodinimo rinkinys / Stādīšanas komplekts / Istatuskomplekt / Комплект за засаждане / Set za sadnju / Set за садњу / Σετ φύτευσης / Kit de plantación / Kit per piantare / Kit de plantio / Kit de plantation / Plantenset

VERTO



15G467 1/18

Tabliczki do roślin

Garden stake tags / Gartenpfahl-Tags / Бирки для садовых кольев / Теги для садовых колов / Növény Címkek / Etichetele plantelor / Štítky rostlin / Štítky rastlín / Oznake rastlin / Augalu etiketēs / Augu etiķetes / Aia vaia sildid / Этикеты за растения / Etikete za biljke / Биљне етикете / Ετικέτες φυτών / Etiquetas de plantas / Etichette vegetali / Rótulos de plantas / Étiquettes de plantes / Labels voor planten

VERTO

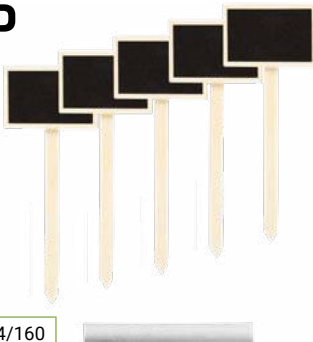

15G460 4/160

Pikownik z trzonkiem drewnianym

Sow dibbler / Pflanzer / Сажалка-лункообразователь / Сажалка-лункоутворювач / Ültetőbot / Plantator rasaduri / Sázeći kolík / Kolík na sadenie / Sadilní klin / Sodinimo įrankis / Stādīšanas rīks / Istatustööriistad / Садило за расад / Klin za sadenje / Садня клина / Φύτευτήρι / Piantatori in acciaio / Foraterra in acciaio / Plantador Bico / Plantoir conique / Pootstok

VERTO



15G425 1/100

Sadzarka ręczna

Hand bulb planter / Manuelle Pflanzmaschine / Ручная сеялка / Ручна саджалка / Kézi ültető, rugós / Plantator manual / Ruční sázeći stroj / Ručný sadzač / Ročni sadilnik / Rankinis sodintuvas / Manuālā sējmašīna / Ръчна саксия / Χειροκίνητη γλάστρα / Jardinera manual / Fioriera manuale / Plantador manual / Planteuse manuelle / Handmatige plantenbak

VERTO



15G426 1/60

Taśma ogrodnicza z siatki

Garden tape / Gartennetzband / Садовая лента / Садова стрічка / Kerti szalag / Bandă de grădină / Zahradní páska / Záhradná páska / Vrtni trak / Sodo juosta / Dārza lente / Aiateip / Градинска лента / Vrtna traka / Баштенска трака / Ταμιά κήπου / Cinta de jardín / Nastro da giardino / Fita de jardim / Ruban de jardin / Tuingaasband

VERTO



15G471 30 mm 1/20

Drut ogrodowy

Garden wire / Gartendraht / Проволока садовая / Дріт садовий / Kötözöbuzal / Sârmă pentru grădină / Zahradní drát / Záhradný drôt / Vrtna žica / Sodo viela / Dārza stieples / Aiatraat / Ten градинарска / Vrtna žica / Ваштенска žica / Σύρμα κήπου / Alambre de jardín / Filo di ferro plastificato / Arame de jardim / Fil de jardin

VERTO



15G530 1.5 mm x 50 m 24/96



15G535 5 mm x 4 m 24/144

Urządzenie do podwiązywania roślin

Plant Tying Machine / Bindezange für Pflanzen / Устройство для подвязывания растений / Садовый степлер / Növénykötöző készülék / Dispositiv pentru legarea plantelor / Zařízení pro vázání rostlin / Zariadenie na viazanie rastlín / Naprava za privezovanje rastlin / Prietaisas augalams rišti / Ierīce augu piesiešanai / Seade taimede sidumiseks / Уред за връзване на растения / Uredaj za vezivanje biljaka / Uređaj za vezivanje biljaka / Συσκευή για δέσιμο φυτών / Dispositivo para atar plantas. / Dispositivo per legare le piante / Dispositivo para amarrar plantas / Dispositif pour attacher les plantes / Apparaat om planten te binden

VERTO



15G455 1/20



Zestaw ogrodniczy

Garden tool set / Gartenwerkzeugset / Комплект садовых инструментов / Комплект городского инструмента / Utántöltő szett növénykötözökhöz / Set unelte de grădinărit / Sada zahradnického nářadí / Súprava záhradného náradia / Komplet vrtnih orodij / Sodo įrankių rinkinys / Dārza instrumentu komplekts / Aiatööriistade komplekt / Комплект градинарски инструменти / Set vrtnog alata / Pribor alata za baštu / Σετ εργαλείων κήπου / Juego de herramientas de jardín / Completo di attrezzi per giardinaggio / Kit de ferramentas / Jeu d'outils / Set van doppen

VERTO



15G456 1/16

x 10000

25 m x 10

Torba ogrodowa

Garden bag / Gartentasche / Садовый мешок / Мішок садовий / Kerti zsák / Sac de grădină / Brašna / Záhradná taška / Vrtna vreča / Sodo krepšys / Dārza soma / Kott / Торба / Torba / Kesa / Τσάντα κήπου / Bolsa de jardín / Borsa da giardino / Saco de jardim / Sac de jardin / Tuinzak

NEO TOOLS



OXFORD 600D

180 g/m²

LONG HANDLES

FOLDABLE

2 HANDLES



15-962 170 L Ø 55 cm 0/12

15-960 85 L Ø 46 cm 0/15

VERTO



PE FOIL

150 g/m²

3 HANDLES

15G541 270 L Ø 67 cm 0/15

Worki na odpady

Waste bags / Beutel für Abfall / Мешки для отходов / Мішки для відходів / Zsák hulladékokhoz / Saci pentru reziduuri / Pytle na odpad / Vreća na odpad / Vreče za odpadke / Šiukšlių maišai / Atkritumu maisi / Jäätmekotid / Чуvalи за отпадъци / Vreče za odpad / Kесе за отпад / Σάκοι αποβλήτων ανθεκτικοί / Bolsas de residuos / Sacchi per rifiuti / Sacos para resíduos / Sacs pour ordures / Afvalzakken, zeer sterk

TOPEX



80L 100 μm x 5

23B257 60x90 cm 0/1



120L 40 μm x 10

23B258 70x110 cm 0/1



240L 45 μm x 10

23B259 120x150 cm 0/1

Obrzeże trawnika

Lawn edges / Rasenrand / Лента газонная (поребрик) / Стрічка бар'єрна газонна / Ágyásszegély / Margine de pajiște / Okraj trawników / Obruby na trávniky / Travníški robniki / Vejos krašto juosta / Zālāja armales / Miguääris / Кант за тревна площ / Rub za travnjake / Ivičnjak za travnjake / Ταίρια οριοθέτησης γκαζόν / Borde para césped / Bordi per aiuole

VERTO

15G510	10 cm x 9 m		0/24
15G511	15 cm x 9 m		0/24
15G512	20 cm x 9 m		0/24
15G513	10 cm x 9 m		0/24
15G514	15 cm x 9 m		0/24
15G515	20 cm x 9 m		0/24



Plandeka

Taraulin / Plane/ Брезентовая покрывка / Тент брезентовый / Ponyva / Prelatā / Plachta / Plachta zakrývacia / Cerada / Brezentas / Pārvalks / Present / Наклон / Nagib / Cerada / Μουσαμάς / Lona / Copertone / Lona / Bâche / Doek

NEO
TOOLS



70
g/m²

79R355	3x4 m		0/1
79R356	4x6 m		0/1
79R357	5x8 m		0/1



85
g/m²

79R364	5x8 m		0/1
79R365	6x10 m		0/1

Wózek transportowy

Multipurpose trolley / Transportwagen / Тележка грузовая / Візок транспортувальний / Szállítókosci / Cărucior de transport / Převavný vozík / Prepravný vozík / Transportni voziček / Maišelis transportavimui / Ratiņi / Veokāru / Транспортна колица / Transportna kolica / Transportna kolica / Καρότσια μεταφοράς / Carretilla de transporte / Carrello di trasporto / Carrinho de transporte / Chariot de manutention / Universele kar

NEO
TOOLS



CAPACITY
80 kg

POLYESTER
600D

FOLDED
70x55x15 cm

84-405	113x90x50 cm		0/1
--------	--------------	--	-----



MAX
CAPACITY
300 kg

84-403	90x60 cm		0/1
--------	----------	--	-----



NEO
TOOLS



MAX LOAD
CAPACITY
200 kg

84-401	113x90x50 cm		0/1
--------	--------------	--	-----



MAX LOAD
CAPACITY
150 kg

84-402	90x60 cm		0/1
--------	----------	--	-----

MAX
120 kg



Pas narzędziowy

Tool belt / Werkzeuggürtel / Сумка для инструмента на пояс / Пасок інструментальний / Szerszámtartó öv / Bandă adevzivă / Montérský pás / Opasok na náradie / Pas za orodje / Monterio diržas / Instrumentu josta / Liimimispressi lint / Колан за инструменти / Pojas za alat / Pojas torbica / Ζώνη μονταρισματος / Cinturón para herramientas reforzado / Cintura per montatore / Cinto p. montagem / Ceinture de monteur / Montageriem

VERTO



6
POCKETS

MAX
118
cm

15G550		0/30
--------	--	------

Mata pod kolana

Knee mat / Коленный коврик / Колінний килимок / Térdvédő párna / Mat de genunchi / Podložka pod kolena / Podložka pod kolená / Podloga za kolena / Kelo kilimélis / Ceja paklājs / Rõlve matt / Подложка за коляно / Podloga za koljena / Подлога за колена / Χαλκι γονάτων / Rodillera / Tappetino per ginocchia / Joelheira / Genouillère / Knie mat

VERTO



EVA
FOAM

2cm

97H200 40x20 cm 0/48

Nakolanniki

Knee protectors / Наколенники / Наколінники / Térdvédők / Perne de genunchi / Chránice kolen / Chránice kolien / Zaščita za koleno / Kelių apsaugos / Ceja aizsargi / Põlvekaitšmed / Наколенници / Štitnici za koljena / Štitnici za kolena / Επιγονατίδες / Rodilleras de protecció / Copriginocchia / Protecção de joelhos / Protège-genoux / Kniebescherming

VERTO



EVA
FOAM

97H201 0/50

Ošlona przeciwodpryskowa

Face protection shield / Splitterschutz / Щиток противоосколочный / Щиток протиосколочний / Arcvédő / Ecran protecție față / Clona proti odpryskům / Ochranný štít / Štitnik za obraz / Apsauginis skydelis veidui / Pretlausku aizsargmaska / Kaitsevisiir / Предпазен щит / Štitnik za lice / Štitnik za lice / Máscara κεφαλής προστασίας από θραύσματα / Máscara protectora facial / Protezione contro schegge / Protecção / Protecteur anti-éclats / Bescherming tegen tegen slingerende deeltjes

NEO
TOOLS



MASK POSITION
LOCK

ADJUSTABLE



97-392 60x90 cm 0/1

Ochraniacz słuchu, głowy i wzroku - 3 w 1

Head, eyes and hearing protector - 3 in 1 / Gehör-, Kopf- und Augenschutz - 3 in 1 / Средство защиты слуха, головы и зрения - 3 в 1 / Засіб захисту слуху, голови та зору - 3 в 1 / Hallás, fej és szemvédelem - 3 az 1-ben / Protecție auz, cap și vedere - 3 în 1 / Chránic sluchu, hlavy a očí - 3 v 1 / Chránic sluchu, hlavy a zraku - 3 v 1 / Varovalo sluha, glave in vida - 3 v 1 / Trys viename - klausos organų, galvos ir regos apsauga / Galvas, dzirdes un redzes aizsargs - 3 vienā / Kõrvade, pea ja silmade kaitse - 3 in 1 / Зашита на слуха, главата и зрението - 3 в 1 / Štitnik sluha, glave i očiju - 3 u 1 / Zaščita za sluh, glavu i vid - 3 u 1 / Μέσο προστασίας ακοής, κεφαλής και όρασης: 3 σε 1 / Protector de oído, cabeza y vista - 3 en 1 / Dispositivo di protezione dell'udito, della testa e della vista - 3 in 1 / Bescherming van het gehoor, hoofd en zicht - 3 in 1

VERTO



3 in 1

55~62cm

EN 397
SAFETY
HELMET

EN 1731
MESH
VISOR

EN 352
EAR MUFFS



97H300 60x90 cm 0/12

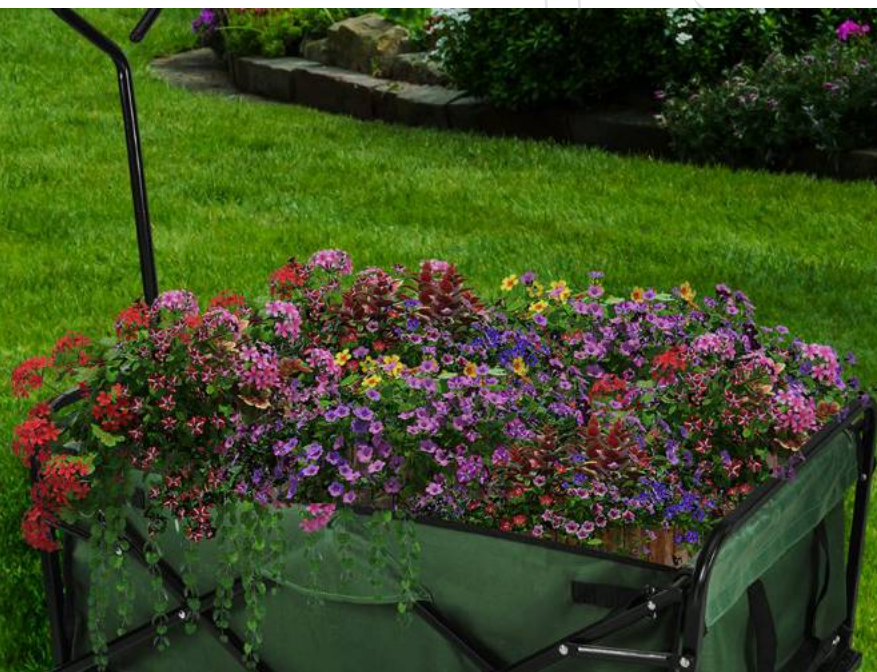



Rękawice robocze

Working gloves / Arbeitshandschuhe / Перчатки рабочие / Рукавици работчи / Védőkesztyű / Mănuși de lucru / Pracovní rukavice / Pracovné rukavice / Delovne rokavice / Darbo pirštīnēs / Darba cimdi / Töökindad / Ръкавици работни / Radne rukavice / Radne rukavice / Γάντια εργασιών / Guantes de trabajo / Guanti di lavoro / Luvas de trabalho / Gants de travail / Werkhandschoenen

NEO
TOOLS



97-608-8	8"	☒	10/100
97-608-9	9"	☒	10/100
97-608-10	10"	☒	10/100

NEO
TOOLS



97-609-8	8"	☒	10/100
97-609-9	9"	☒	10/100
97-609-10	10"	☒	10/100

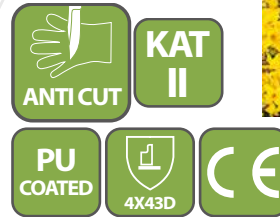

NEO
TOOLS



97-610-8	8"	☒	10/100
97-610-9	9"	☒	10/100
97-610-10	10"	☒	10/100

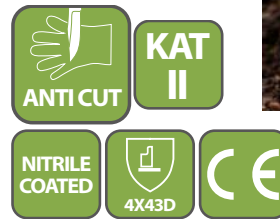

NEO
TOOLS



97-616-8	8"	☒	10/100
97-616-9	9"	☒	10/100
97-616-10	10"	☒	10/100



NEO
TOOLS



97-617-8	8"	☒	10/100
97-617-9	9"	☒	10/100
97-617-10	10"	☒	10/100
97-617-11	11"	☒	10/100



NEO
TOOLS



97-620-8	8"	☒	10/100
97-620-9	9"	☒	10/100
97-620-10	10"	☒	10/100



Rękawice robocze

Working gloves / Arbeitshandschuhe / Перчатки рабочие / Рукавици работчи / Védőkesztyű / Mănuși de lucru / Pracovní rukavice / Pracovné rukavice / Delovne rokavice / Darbo pirštinės / Darba cimdi / Töökindad / Ръкавици работни / Radne rukavice / Radne rukavice / Γάντια εργασις / Guantes de trabajo / Guanti di lavoro / Luvas de trabalho / Gants de travail / Werkhandschoenen

NEO
TOOLS

97-621-8	8"		10/100
97-621-9	9"		10/100
97-621-10	10"		10/100
97-621-11	11"		10/100



KAT
II

NITRILE
COATED



4131X



NEO
TOOLS

97-630-8	8"		10/100
97-630-9	9"		10/100
97-630-10	10"		10/100



KAT
II

NITRILE
COATED



4121X

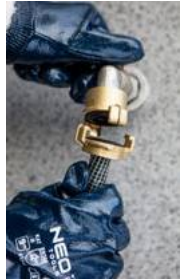

NEO
TOOLS

97-631-8	8"		10/100
97-631-9	9"		10/100
97-631-10	10"		10/100



KAT
II

NITRILE
COATED



4111X



NEO
TOOLS

97-640-8	8"		10/100
97-640-9	9"		10/100
97-640-10	10"		10/100



KAT
II

LATEX
COATED



2143X



NEO
TOOLS

97-641-8	8"		10/100
97-641-9	9"		10/100
97-641-10	10"		10/100
97-641-11	11"		10/100



KAT
II

LATEX
COATED



3131X



NEO
TOOLS

97-642-8	8"		10/100
97-642-9	9"		10/100
97-642-10	10"		10/100



KAT
II

NITRILE
COATED



4131X



Rękawice robocze

Working gloves / Arbeitshandschuhe / Перчатки рабочие / Рукавици робочі / Védőkesztyű / Mănuși de lucru / Pracovní rukavice / Pracovné rukavice / Delovne rokavice / Darbo pirštinės / Darba cimdi / Töökindad / Ръкавици работни / Radne rukavice / Radne rukavice / Γάντια εργασιών / Guantes de trabajo / Guanti di lavoro / Luvas de trabalho / Gants de travail / Werkhandschoenen

NEO
TOOLS

97-643-8	8"		10/100
97-643-9	9"		10/100
97-643-10	10"		10/100
97-643-11	11"		10/100



KAT II

2x LATEX COATED



NEO
TOOLS

97-644-3	3"		10/100
97-644-4	4"		10/100
97-644-5	5"		10/100



KAT I

FOR CHILDREN

POLYESTER LATEX COATED



NEO
TOOLS

97-690-M	M		10/100
97-690-L	L		10/100
97-690-XL	XL		10/100



EXTRA GRIP

POWDER FREE

LATEX FREE
100% NITRILE
SILICONE FREE

x 50



NEO
TOOLS

97-691M	M		10/100
97-691-L	L		10/100
97-691-XL	XL		10/100



EXTRA GRIP

POWDER FREE

LATEX FREE
100% NITRILE
SILICONE FREE

x 50



VERTO

97H120	8"		12/120
97H121	9"		12/120
97H122	10"		12/120
97H122	11"		12/120



KAT II



VERTO

97H136	8"		12/120
97H137	9"		12/120
97H138	10"		12/120
97H139	11"		12/120



KAT II

PU COATED



Rękawice robocze

Working gloves / Arbeitshandschuhe / Перчатки рабочие / Рукавици робочи / Védőkesztyű / Mănuși de lucru / Pracovní rukavice / Pracovné rukavice / Delovne rokavice / Darbo pirštīnēs / Darba cimdi / Töökindad / Ръкавици работни / Radne rukavice / Radne rukavice / Γάντια εργασιών / Guantes de trabajo / Guanti di lavoro / Luvas de trabalho / Gants de travail / Werkhandschoenen

VERTO

97H140	7"	☒	12/120
97H141	8"	☒	12/120
97H142	9"	☒	12/120



KAT
II

NITRILE
COATED



4131X



VERTO

97H143	7"	☒	12/120
97H144	8"	☒	12/120
97H145	9"	☒	12/120



KAT
II

PU
COATED



4131X



VERTO

97H146	7"	☒	12/120
97H147	8"	☒	12/120
97H148	9"	☒	12/120



KAT
I



VERTO

97H151	8"	☒	12/120
97H152	9"	☒	12/120
97H153	10"	☒	12/120



KAT
II

NITRILE
COATED



4131X



Kalosze

Rubber boots / Gummistiefel / Γαλοσι / Чоботи / Gumicsizma / Cizme cauciuc / Holínky / Gumáky / Galoše / Gminniai batai / Galošas / Kummikud / Гумени ботуши / Gumene čizme / Čizme za kišu / Γαλότσες από / Botas de agua / Calosce / Galochas / Bottes en caoutchouc / Laarzen

NEO
TOOLS



S4
SRC



82-900-40	40		0/6
82-900-41	41		0/6
82-900-42	42		0/6
82-900-43	43		0/6
82-900-44	44		0/6
82-900-45	45		0/6
82-900-46	46		0/6
82-900-47	47		0/6

NEO
TOOLS



OB
SRC



82-901-40	40		0/6
82-901-41	41		0/6
82-901-42	42		0/6
82-901-43	43		0/6
82-901-44	44		0/6
82-901-45	45		0/6
82-901-46	46		0/6

NEO
TOOLS



PVC



82-902-40	40		0/6
82-902-41	41		0/6
82-902-42	42		0/6
82-902-43	43		0/6
82-902-44	44		0/6
82-902-45	45		0/6
82-902-46	46		0/6

VERTO



EVA
FOAM



15G930	40		0/6
15G931	41		0/6
15G932	42		0/6
15G933	43		0/6
15G934	44		0/6
15G935	45		0/6
15G936	46		0/6
15G937	47		0/6
15G908	47		0/6

Gumofilce

Felt rubber boots / Filzgummistiefel / Сапоги резиновые с войлоком / Повстяні черевики на каучуковій підшві / Gumicsizma, filcbetétes / Cizme din cauciuc cu pâslă / Gumofilcové holínky / Filcové gumáky / Gumijasti škornji s filcem / Guminiai batai / Gumijas zăbaki ar filcu / Voodriga kummikud / Работни гумени ботуши с филц / Gumene čizme s filcom / Gumene čizme / Μητότες λαστιχένιες με κελσό / Botas de agua con fieltro / Calosce con feltro / Galochas com feltro / Bottes en caoutchouc avec doublure en feutre / Rubberlaarzen

VERTO



PVC



15G900	39		0/6
15G901	40		0/6
15G902	41		0/6
15G903	42		0/6
15G904	43		0/6
15G905	44		0/6
15G906	45		0/6
15G907	46		0/6
15G908	47		0/6



Odstraszacz solarny

Solar deterrent / Solare Abschreckung / Солнечный отпугиватель / Відлякувач сонячних променів / Napelemes kártevőriasztó / Dispositiv solar de descurajare / Solární odstrašující prostředek / Solární odvracální element / Saulės atgrasymo priemonė / Saules atbaidīšanas līdzeklis / Πάικεσετρίεβηαhend / Соларен възπиращ елемент / Solarni repelent / Соларни репелент / Ηλιακός αποτρεπτικός μηχανισμός / Disuasor solar / Deterrente solare / Dissuasor solar / Dissuasion solaire / Zonneschrikmiddel

VERTO



15G441 0/30

x2

SOLAR PANEL

ANIMAL & HUMAN SAFE

Słupek ogrodowy solarny

LED solar garden post / LED-Solar-Gartenpfosten / Светодиодный садовый столб на солнечных батареях / Світлодіодний сонячний садовий стовп / Napelemes kerti állólámpa / LED solar gradina post solar / LED solární zahradní sloupek / LED solárny záhradný stĺpik / LED sončna vrtna pošta / LED saulės sodo stulpas / LED saules dārza stabs / Πάικεσε-LED αιπόλλαρ / LED сльнчев градински стълб / Solární LED vrtní stupic / Соларни ЛЕД баштенски стуб / LED ηλιακή κήπου post / Poste solar LED para jardín / Palo da giardino solare a LED / Poste de jardim solar LED / Poteau de jardin solaire LED / LED solar tuinpaal

NEO TOOLS



99-113 430 mm 0/30

SOLAR PANEL

LED

STAINLESS STEEL

CHARGING TIME 8 h

WORKING TIME 6-8h

1,2V 100mAh Ni-CD AA

IP44

Lampa fasadowa

Exterior wall lamp / Fassadenleuchte / Фасадный светильник / Фасадний світильник / Kültéri lámpa / Lampă de fațadă / Fasádní lampa / Fasádne svietidlo / Fasadna svetilka / Fasadinis šviestuvus / Fasādes lampa / Fassaadilamp / Фасадна лампа / Fasadna lampa / Fasadna lampa / Φωτιστικό πρόσοψης / Lámpara de fachada / Lampada per facciate / Candeeiro de fachada / Lampe de façade / Gevellamp

NEO TOOLS



99-079 h = 235 mm 0/30

STAINLESS STEEL

MAX 13W LED

IP44

220 ~ 240V 50hz

Lampa ogrodowa słupek

Garden post lamp / Gartenleuchte Pfosten / Садовый светильник столбик / Садовий світильник стовпчик / Kerti állólámpa / Lampă de grădină pe stâlp / Zahradní lampa sloupek / Stĺpová záhradná lampa / Vrtna svetilka, stebriček / Stulpinis sodo šviestuvus / Dārza lampa stabiņa formā / Aialamp post / Градинска лампа, стълб / Vrtna lampa ubodna / Baštenska lampa ubodna / Στύλος φωτιστικό κήπου / Lámpara de jardín con poste / Lampada da giardino palo / Candeeiro de jardim de pé / Lampe de jardin poteau / Tuinlamp paa

NEO TOOLS



99-080 h = 500 mm 0/30

99-081 h = 800 mm 0/30

STAINLESS STEEL

MAX 13W LED

IP44

220 ~ 240V 50hz

Lampa solarna

Solar lamp / Solarleuchte Pfosten / Солнечный светильник столбик / Сонячний світильник стовпчик / Napelemes kerti lámpa / Lampă solară pe stâlp / Solární lampa sloupek / Stĺpová solárna lampa / Solarna svetilka, stebriček / Stulpinis šviestuvus su saulės energija / Solārā lampa stabiņa formā / Πάικεσετοίελ lamp post / Соларна лампа, стълб / Solarna lampa / Solarna lampa ubodna / Στύλος ηλιακός λαμπτήρας / Lámpara solar con poste / Lampada solare palo / Candeeiro solar em pé / Lampe solaire poteau / Zonne-energie lamp paal

NEO TOOLS



99-084 1/32

STAINLESS STEEL + GLASS

SOLAR PANEL

SOLAR POWER 1,2V 600mAh NI-MH AA 2V/160 mA

WORKING TIME 8-10h

10lm IP44

CHARGING TIME 6-8h



99-085 0/30

SOLAR PANEL

180 lm

3,7V 2200mAh Li-ion

OFF ON

LED

WORKING TIME 8-10h

IP44

CHARGING TIME 6-8h

PP

Lampa solarna

Solar lamp / Солнечная лампа / Lampă solară / Napelemes lámpa / Соляная лампа / Solárna lamp / Solárni lamp / Solarlampe / Solárna lamp / Saulės lempa / Saules lamp / Päikeselamp / Слънчева лампа / Solarna lamp / Соларна лампа / Ηλιακός λαμπτήρας / Lámpara solar / Lampada solare / Luminária solar / Lampe solaire / Zonne-lamp

NEO
TOOLS



FLAME EFFECT	
SMD LED	3,7V 1200mAh Li-ion
OFF ON	SOLAR PANEL
CHARGING TIME 8 h	WORKING TIME 8 h
35 lm	IP44

99-057 h = 780 mm 0/16



x4	ABS
SMD LED	1,2V 600mAh Ni-MH AA
OFF ON	SOLAR PANEL
CHARGING TIME 8 h	WORKING TIME 8 h
10 lm	IP44

99-058 190 mm 0/16

NEO
TOOLS



LED	OFF ON	SOLAR PANEL
20 lm	CHARGING TIME 6-8h	WORKING TIME 8 h
AL + PLASTIC	MAX 30 t	IP65

99-086 0/16



LED	1,2V 600mAh Ni-MH AA
OFF ON	SOLAR PANEL
CHARGING TIME 6-8h	WORKING TIME 8-10h
STAINLESS STEEL + PLASTIC	50 lm
	IP65

99-087 0/16

NEO
TOOLS



17 LED	3,7V 1200mAh Li-ion
OFF ON	SOLAR PANEL
CHARGING TIME 8 h	WORKING TIME 12h
30 lm	IP65

99-108 0/16

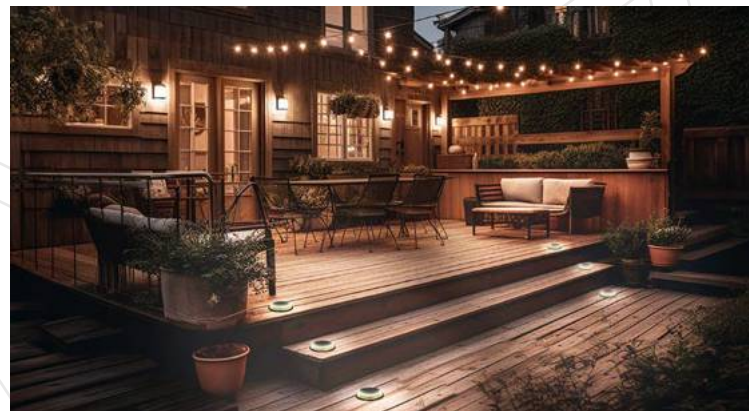

Girlanda

Girlanda / Garland / Girlande / Гирлянда / Гирлянда / Kerti fényfűzér / Ghirlandă / Girlanda / Girlanda / Venček / Girlianda / Virtene / Garland / Гирлянд / Girlanda / Гарланд / Γυρλάντα / Guirnalda / Ghirlanda / Grinalda / Guirlande / Slinger

NEO
TOOLS

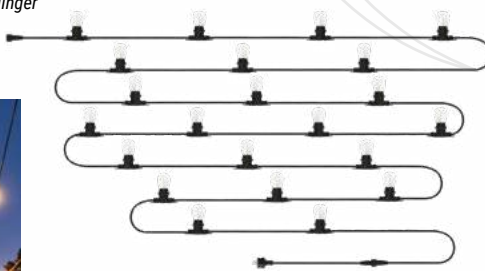

20 m	20+2 BULBS	E27	1W	IP65 IP45
------	------------	-----	----	--------------

99-106 0/16







x5		
FOR 99-106	E27	1W

99-111 0/16

Lampa biwakowa

Camping lamp / Campinglampe / Лампа для кемпинга / Кемпінг лампа / Kempinglámpa / Lampă de camping / Camping lamp / Camping lamp / Svetilka za kampiranje / Stovyklavimo lempa / Kepinga lamp / Matkalamp / Лампа за къмпинг / Svjetiljka za kampiranje / Лампа за камповање / Лампа къмпинг / Lámpara de camping / Lampada da campeggio / Lâmpada de acampamento / Lampe de camping / Camping lamp

NEO
TOOLS

-  1st click: **FRONT LIGHT**
max 4 h
-  2nd click: **SIDE LIGHT**
max 7 h
-  3rd click: **SIDE RED LIGHT**
max 7 h
-  4rd click: **SIDE RED STROBE**



3 in 1

LAMP

TORCH

POWER BANK



LAMP



TORCH

EMERGENCY
RED LIGHT



3W
MAX
200 lm

x3
AA

COB
LED



99-031  0/30

CREE
T6 LED

SMD
LED

10W
MAX
800 lm

3,7V
1200mAh
Li-ion
x2

CHARGING
TIME
6 h

USB

99-030  0/30

Promiennik

Infrared heater / Heizkörper / Радиатор / Радиатор / Halogén hőszugárzó / Radiator / Radiátor / Radiator / Infrardeči grelec / Infraraudonųjų spindulių šildytuvas / Infrasarkanais sildītājs / Infrapuna kütteseade / Инфрачервен нагревател / Infracrveni grijač / Инфрацрвени грејач / Υπερύθρη θερμίστρα / Calentador de infrarrojos / Riscaldatore a infrarossi / Infrarood verwarming / Chauffage infrarouge

NEO
TOOLS



90-034  0/2



1,5
kW

3-4m²

HALOGEN
LAMP

5000h

IP44



NEO
TOOLS



90-037  0/1



1,5
kW

2-3m²

HALOGEN
LAMP

5000h

IP44

ALUMINIUM
BODY

NEO
TOOLS



90-038  0/1



2
kW

3-4m²

HALOGEN
LAMP

6000h

IP44

ALUMINIUM
BODY







NEO
TOOLS

VERTO